

SITE PLAN MONTECRISTO

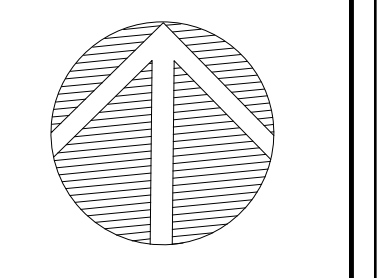

PRESIDENCIA DE LA REPÚBLICA DOMINICANA

 Proyectos Estratégicos y Especiales

PROPEEP

ING. TOMÁS MENDEZ

 TOMAS.MENDEZ@PROPEEP.GOB.DO

 ING. SARA DOMÍNGUEZ

 SARA.DOMINGUEZ@PROPEEP.GOB.DO

 ARQ. JUAN CARLOS BERRIOA

 JUAN.BERRIOA@PROPEEP.GOB.DO

PROYECTO:

ECO-VIVIENDAS

DESCRIPCIÓN:

 ...

DISEÑO ARQUITECTÓNICO:

 ...

DISEÑO ESTRUCTURAL:

 ...

DISEÑO ELÉCTRICO:

 ...

DISEÑO SANITARIO:

 ...

...

NO.	FECHA	REALIZADO	REVISADO	APROBADO
1				
2				
3				
4				
5				
6				
7				
8				
9				
10				

...

DISCIPLINA:	ARQUITECTURA	ESCALA:	A-00
FECHA:	JUNIO 2022	OP. INDICADA:	0
INDICADA:	INDICADA	OP. INDICADA:	0

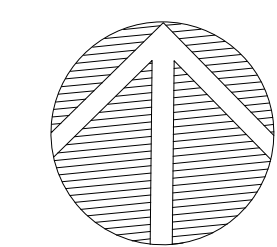

18.98

6.78

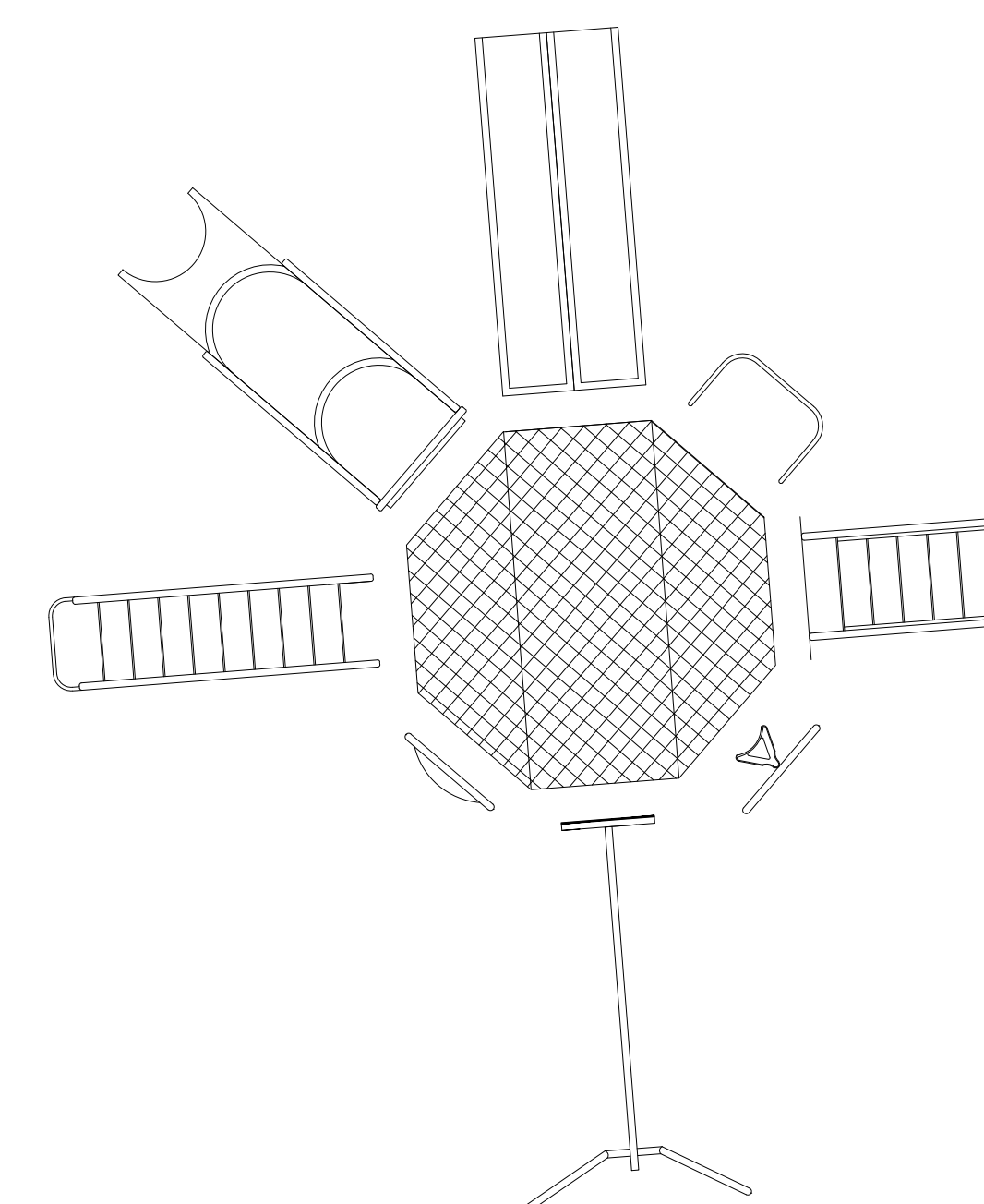
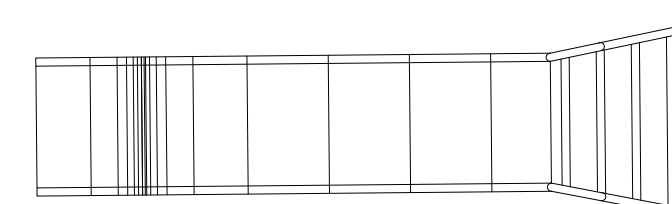
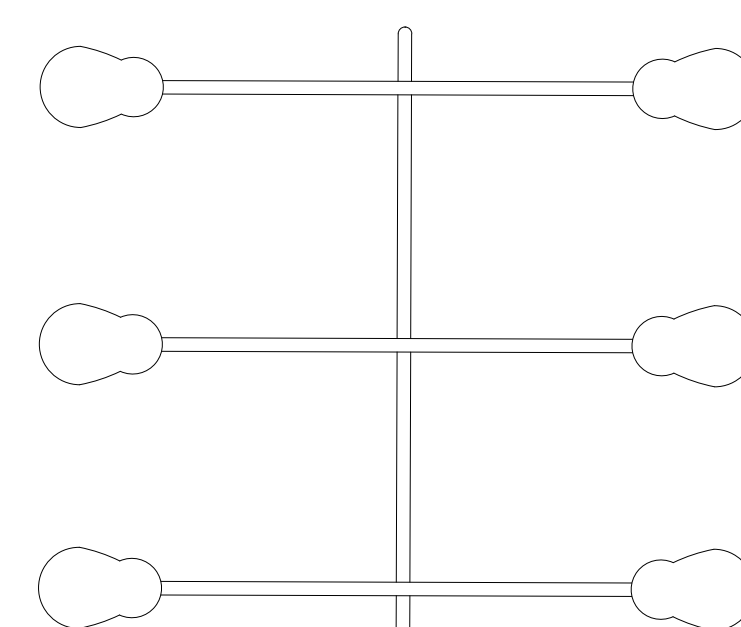
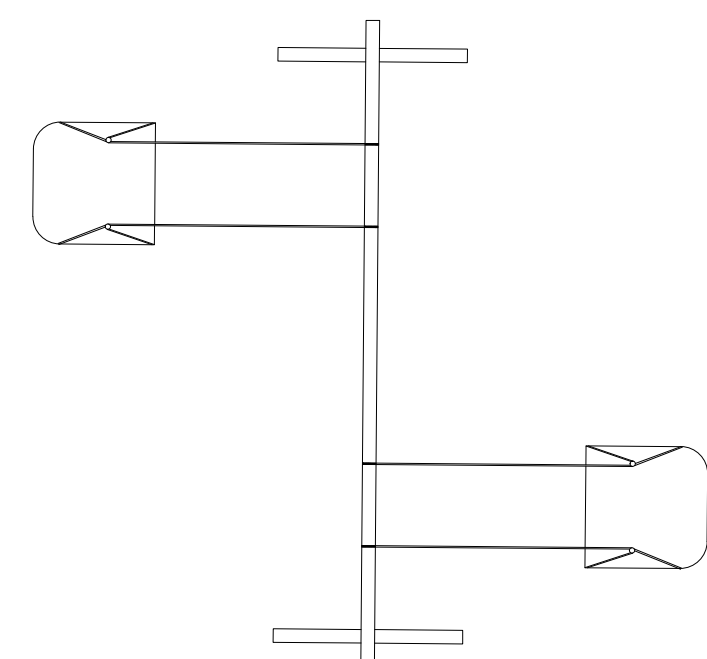
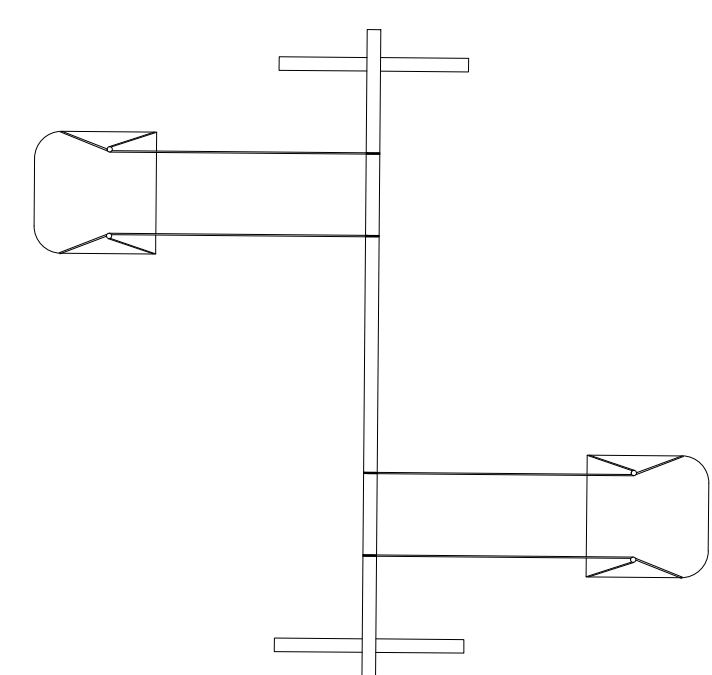

ÁREA DE JUEGO DE NIÑOS

PLANTA ARQ.ÁREA DE NIÑOS

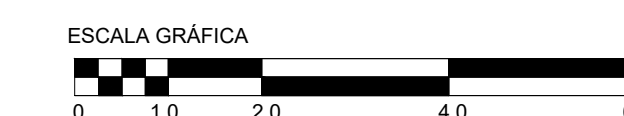

DISCIPLINA	ARQUITECTURA	FECHA	JUNIO 2022
INDICADA		INDICADA	

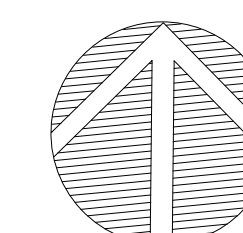

 PRESIDENCIA DE LA
REPÚBLICA DOMINICANA
 Proyectos Estratégicos y Especiales
PROPEEP

ING. TOMÁS MENDEZ
 TOMAS.MENDEZ@PROPEEP.GOB.DO
 ING. SARA DOMÍNGUEZ
 SARA.DOMINGUEZ@PROPEEP.GOB.DO
 ARO. JUAN CARLOS HERRERA
 JUAN.HERRERA@PROPEEP.GOB.DO

PROYECTO:
ECO-VIVIENDAS

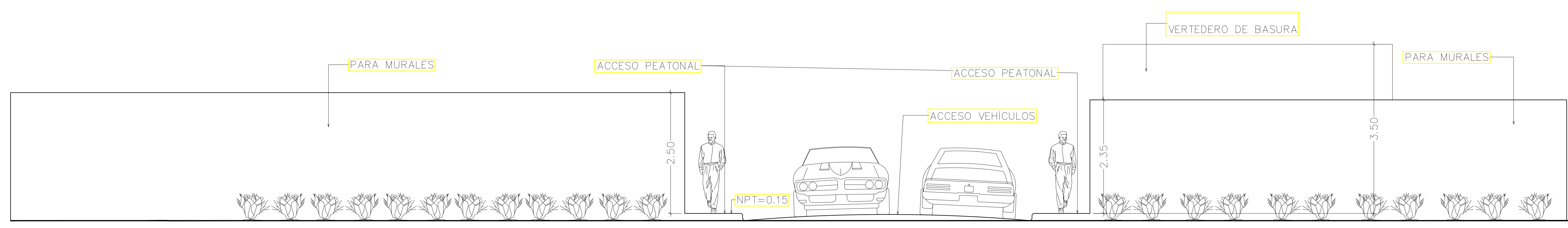

FACHADA FRONTAL ACCESO AL PROYECTO

ELEVACIÓN FRONTAL VERJA

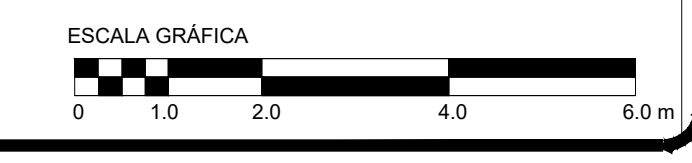

DISEÑO ARQUITECTÓNICO

PROYECTISTA: _____
 FECHA: _____

DISEÑO ESTRUCTURAL

PROYECTISTA: _____
 FECHA: _____

DISEÑO ELÉCTRICO

PROYECTISTA: _____
 FECHA: _____

DISEÑO SANITARIO

PROYECTISTA: _____
 FECHA: _____

NO.	FECHA	REALIZADO	REVISADO	APROBADO
1				
2				
3				
4				
5				
6				
7				
8				
9				
10				

OBSERVACIONES:

DISCIPLINA: ARQUITECTURA	ESCALA: A-00
FECHA: JUNIO 2022	OP. REALIZADA: 0
VERBA: INDICADA	OP. INDICADA: 0

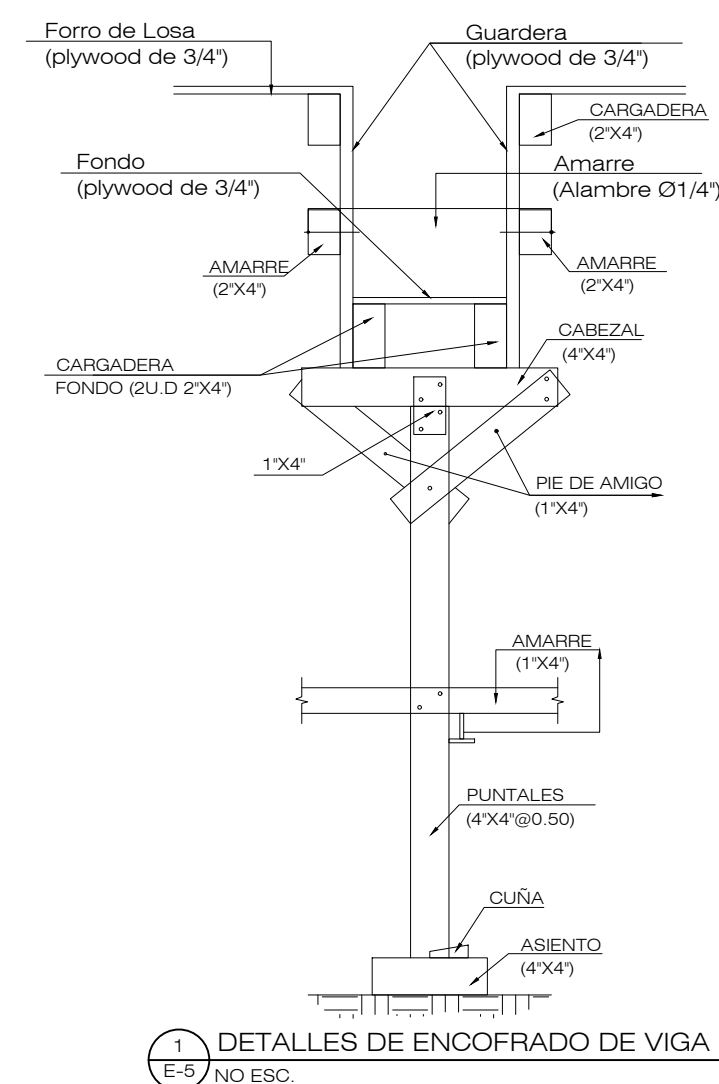
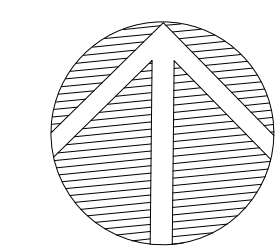

1 DETALLES DE ENCOFRADO DE VIGA
E-5 NO ESC.

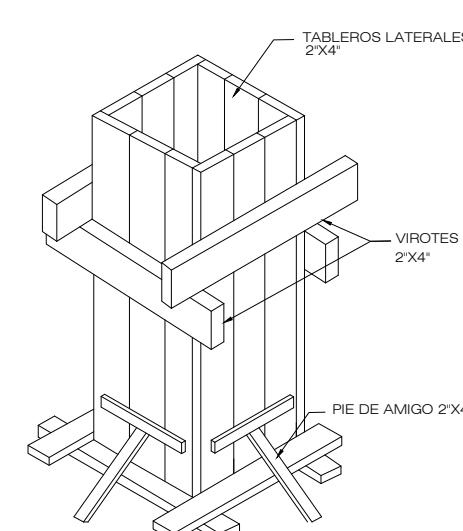

2 PERSPECTIVA ENCOFRADO DE COLUMNA
E-5 NO ESC.

TIEMPO DE DEENCOFRADO

	TIEMPO DE DEENCOFRADO (DIAS)
VIGAS Y LOSAS AUTOPORTANTES	10
MUROS Y COLUMNAS	3
PISOS Y PAVIMENTOS	2

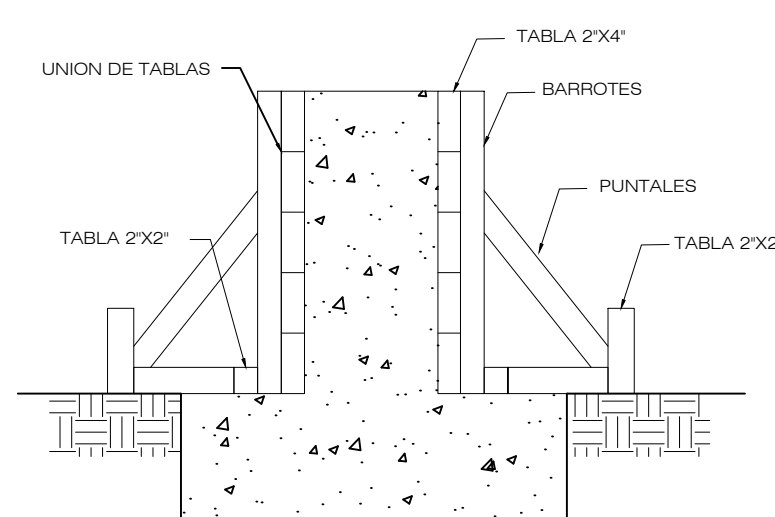

3 DETALLES TÍPICO DE ENCOFRADO DE MURO
E-5 NO ESC.

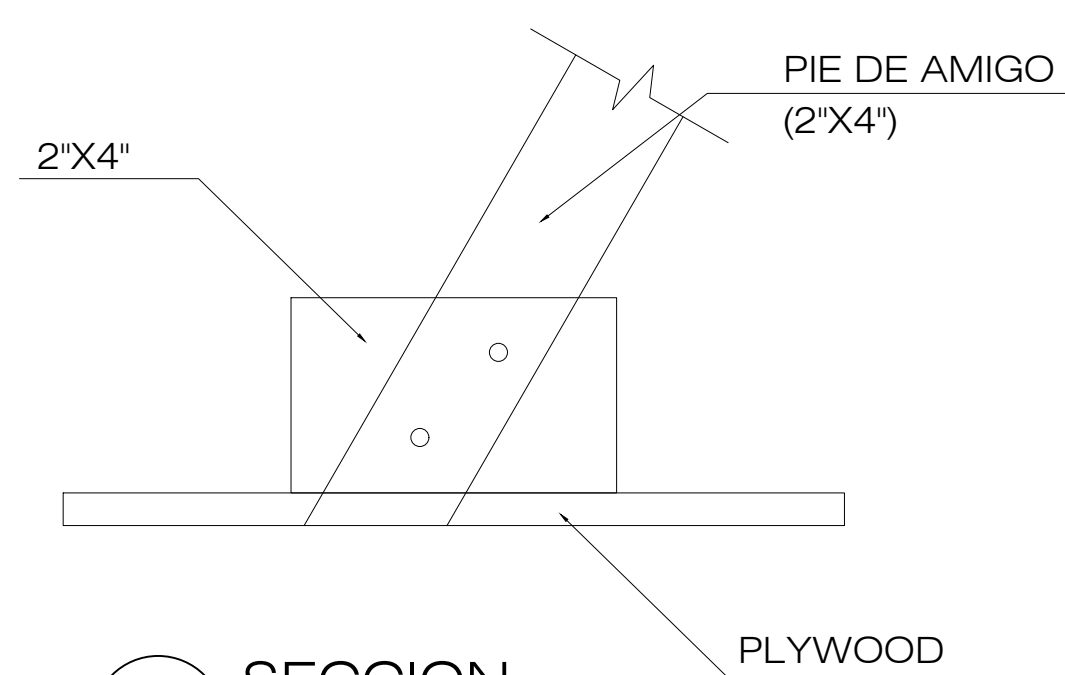

4 SECCION
E-5 NO ESC.

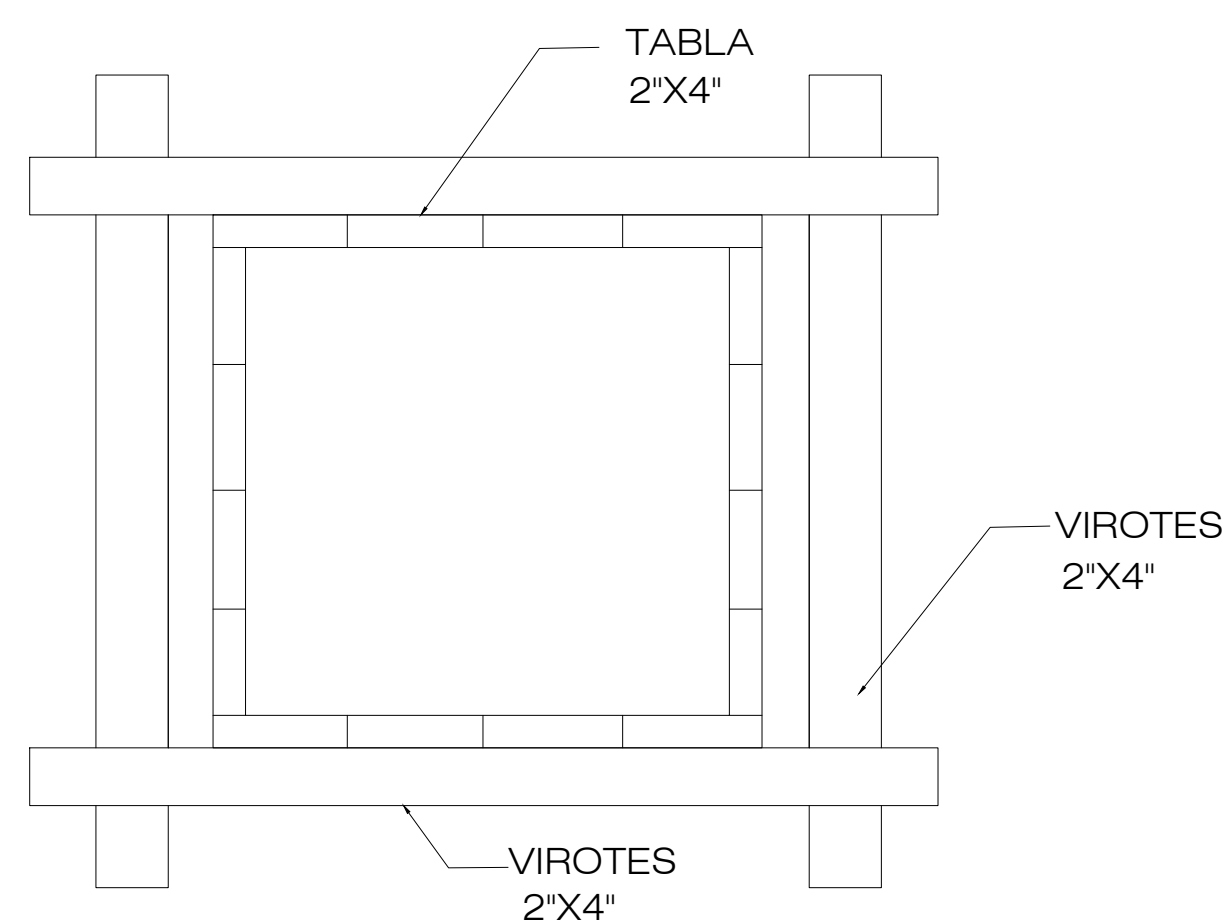

5 DETALLES TÍPICO DE ENCOFRADO DE COLUMNA
E-5 NO ESC.

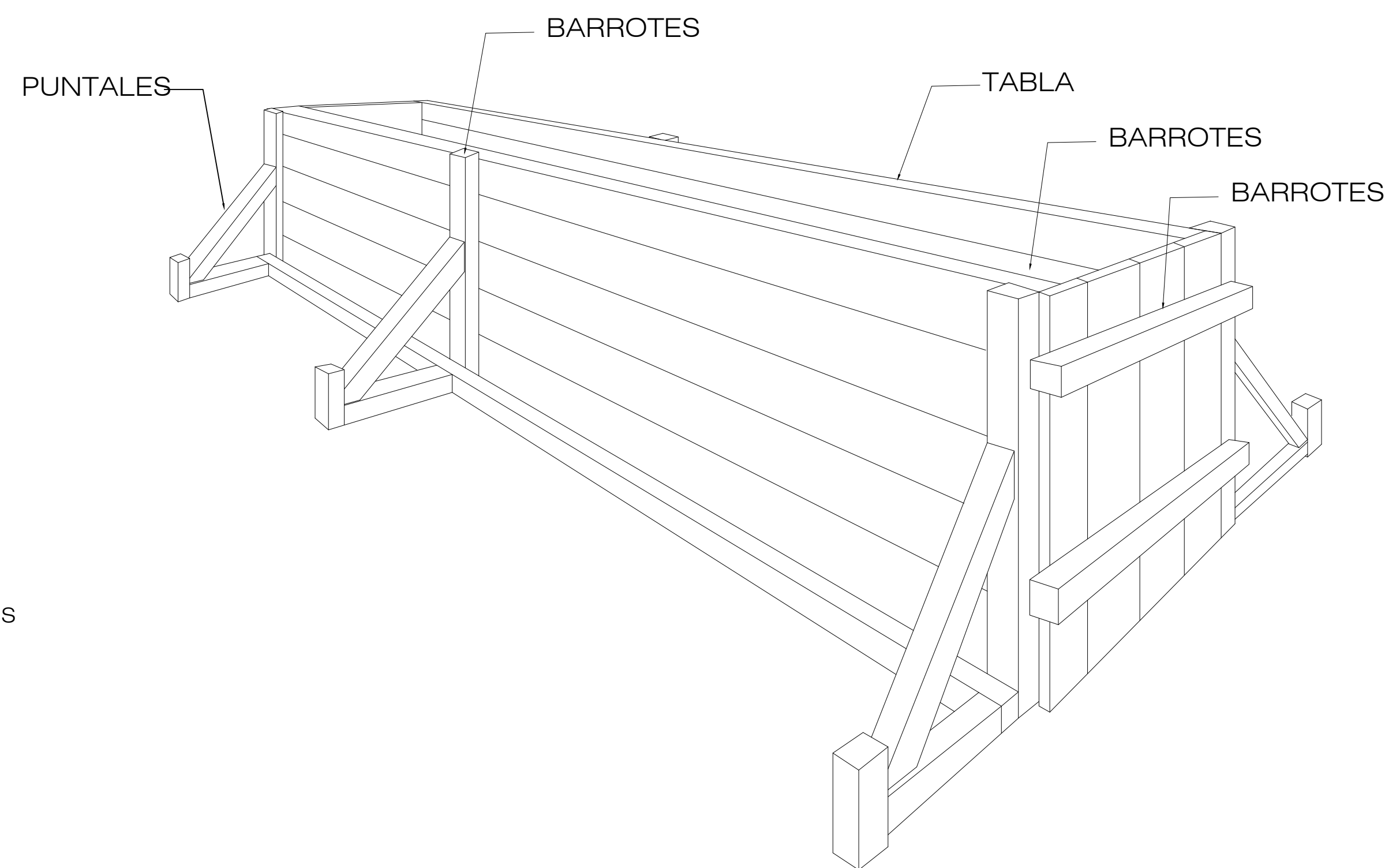

8 PERSPECTIVA ENCOFRADO DE MURO
E-5 NO ESC.

DETALLE DE ENCOFRADO

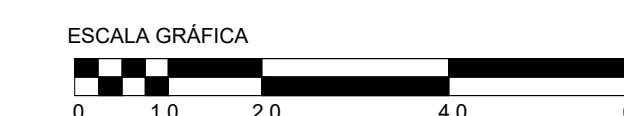

DISEÑO ARQUITECTÓNICO

DISEÑO ESTRUCTURAL

DISEÑO ELÉCTRICO

DISEÑO SANITARIO

NO.	FECHA	REALIZADO	REVISADO	APROBADO
1				
2				
3				
4				
5				
6				
7				
8				
9				
10				

DISCIPLINA: ARQUITECTURA

PROYECTO: A-00

FECHA: JUNIO 2022

INDICADA

TAPA SANITARIA DEL POZO

SELLO DE MORTERO

TUBERÍA DE AGUA

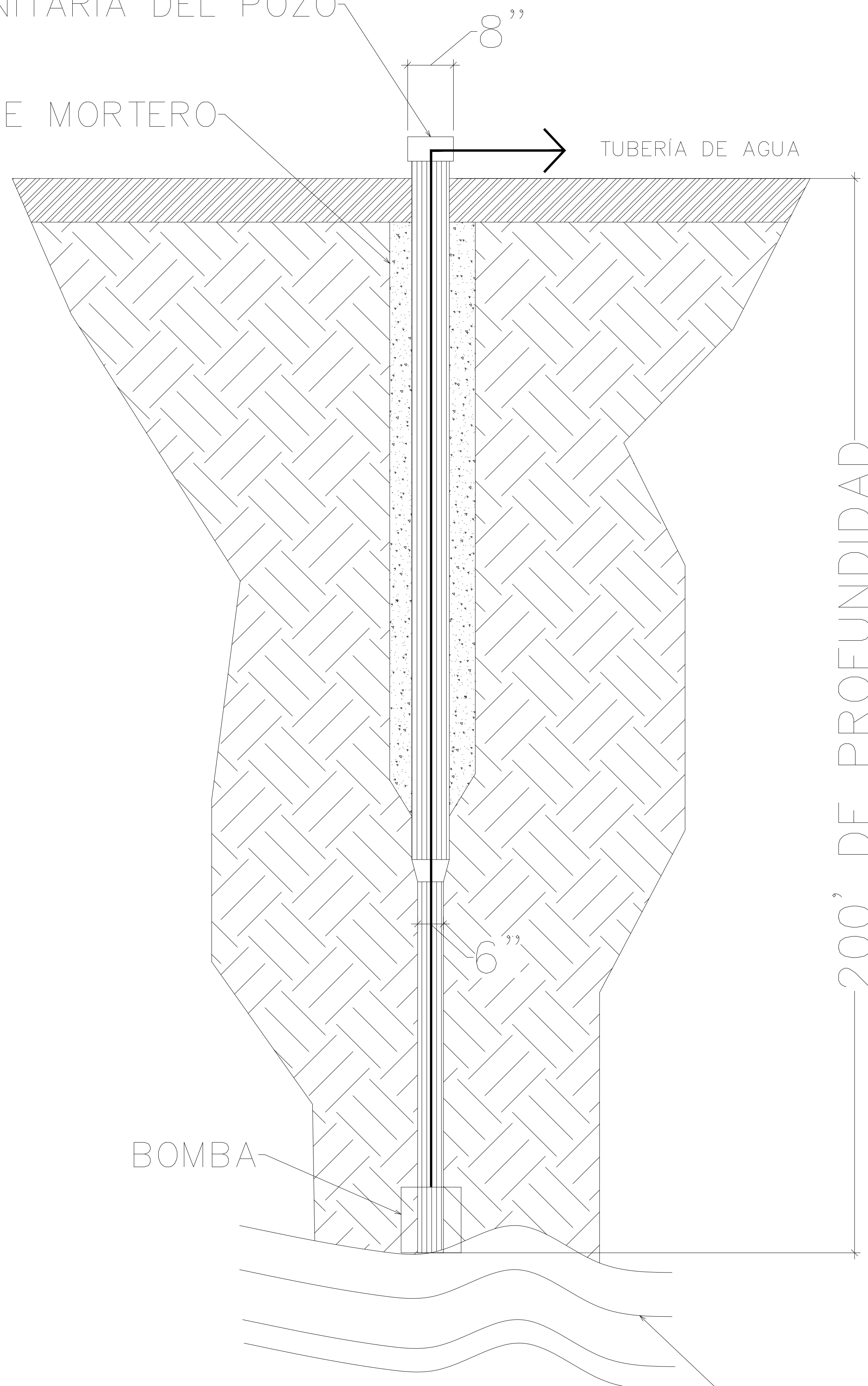

200' DE PROFUNDIDAD

BOMBA

AGUA ESTANCADA EN POZO

DETALLE POZO FILTRANTE

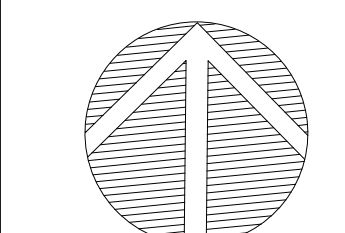
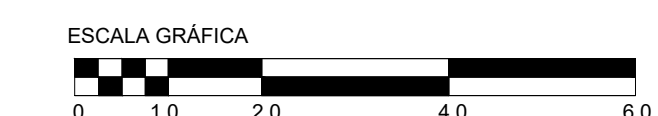

 PRESIDENCIA DE LA
 REPÚBLICA DOMINICANA
 Proyectos Estratégicos y Especiales
PROPEEP

ING. TOMÁS MENDEZ
 TOMAS.MENDEZ@PROPEEP.GOB.DO
 ING. SARA DOMÍNGUEZ
 SARA.DOMINGUEZ@PROPEEP.GOB.DO
 ARQ. JUAN CARLOS HERRERA
 JUAN.HERRERA@PROPEEP.GOB.DO

PROYECTO:
ECO-VIVIENDAS

DISEÑO ARQUITECTÓNICO

DISEÑO ESTRUCTURAL

DISEÑO ELÉCTRICO

DISEÑO SANITARIO

NO.	FECHA	REALIZADO	REVISADO	APROBADO
1				
2				
3				
4				
5				
6				
7				
8				
9				
10				

DISCIPLINA: ARQUITECTURA
 ESCALA: A-00
 FECHA: JUNIO 2022
 FORMA: INDICADA

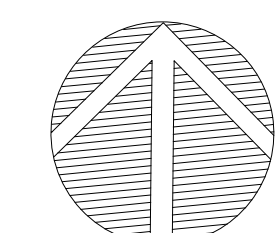

NO.	FECHA	REALIZADO	REVISADO	APROBADO
1				
2				
3				
4				
5				
6				
7				
8				
9				
10				

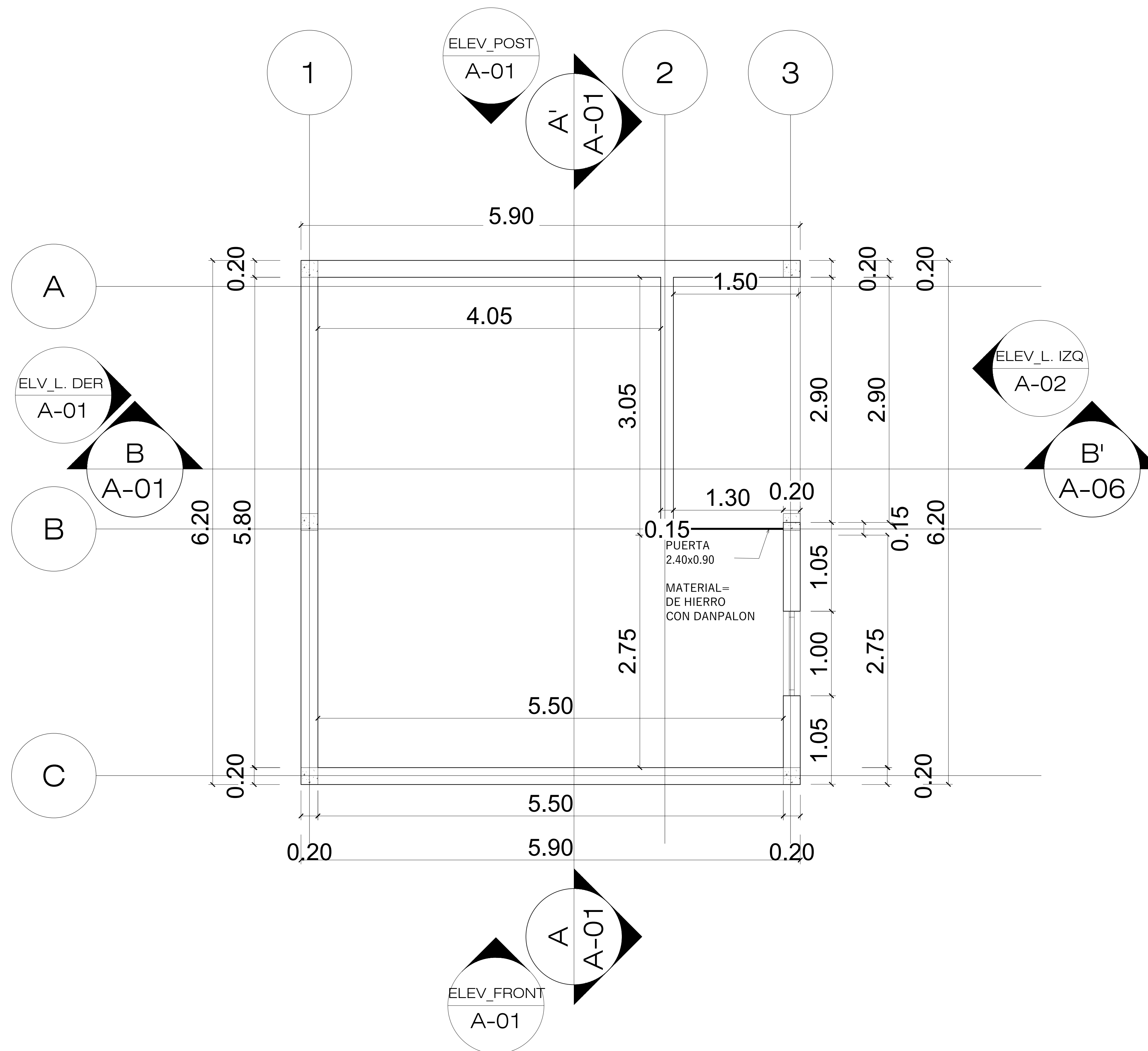

DEPOSITO DE BASURA

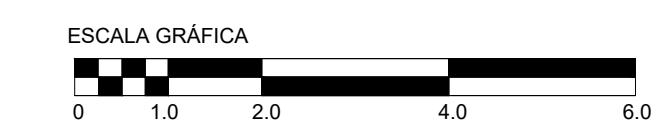

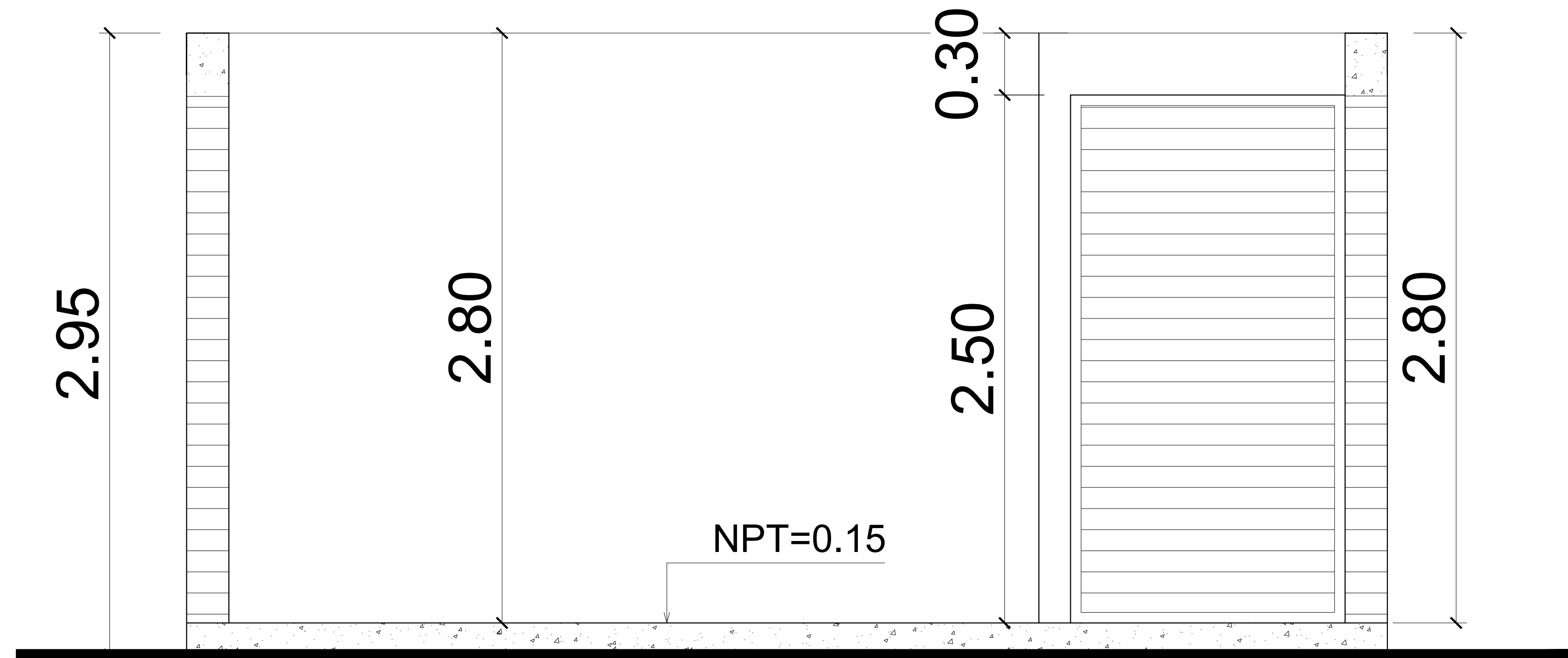
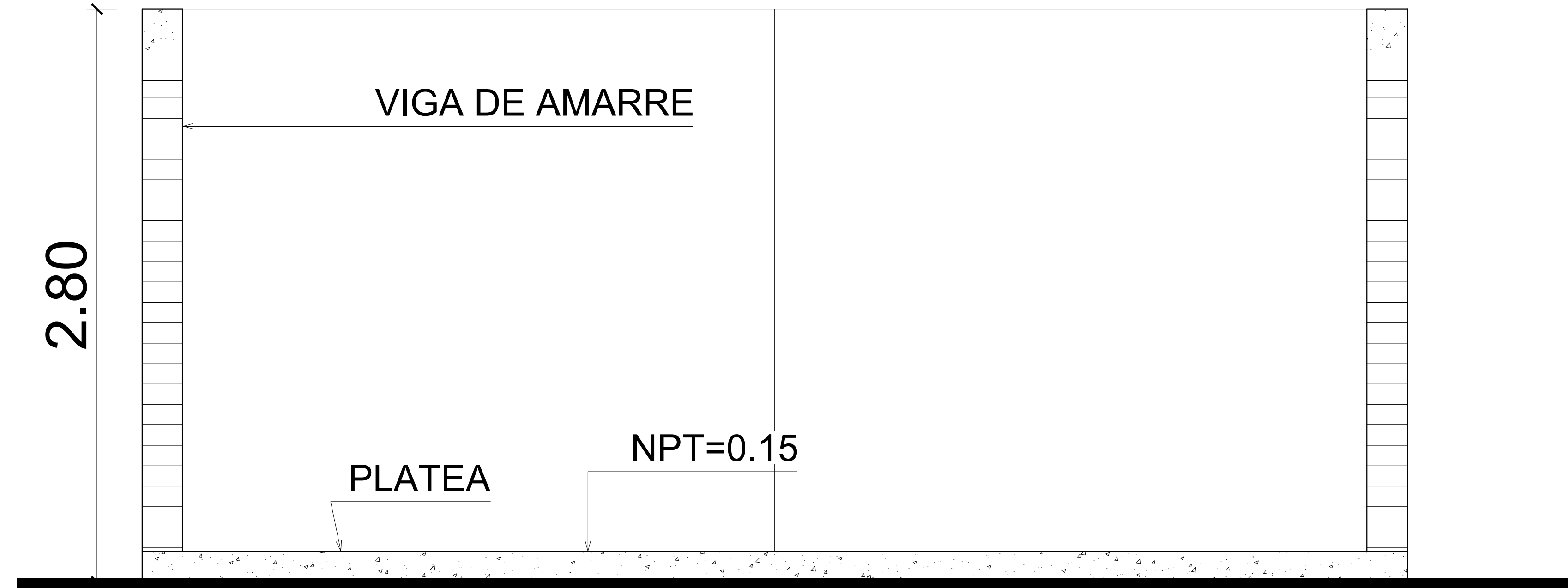

ELEVACIÓN DEPOSITO DE BASURA

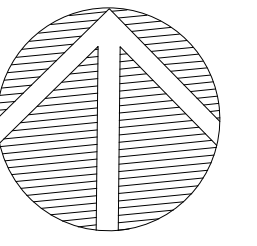

PRESIDENCIA DE LA REPÚBLICA DOMINICANA
 Proyectos Estratégicos y Especiales
PROPEEP

ING. TOMÁS MENDEZ
 TOMAS.MENDEZ@PROPEEP.GOB.DO
 ING. SARA DOMÍNGUEZ
 SARA.DOMINGUEZ@PROPEEP.GOB.DO
 ARQ. JUAN CARLOS BEFERRA
 JUAN.BEFERRA@PROPEEP.GOB.DO

PROYECTO:
ECO-VIVIENDAS

DISEÑO ARQUITECTÓNICO

DISEÑO ESTRUCTURAL

DISEÑO ELÉCTRICO

DISEÑO SANITARIO

NO.	FECHA	REALIZADO	REVISADO	APROBADO
1				
2				
3				
4				
5				
6				
7				
8				
9				
10				

DISCIPLINA:	ARQUITECTURA	ESCALA:	A-00
FECHA:	JUNIO 2022	OP. REALIZADA:	0
INDICADA:	INDICADA	OP. INDICADA:	0

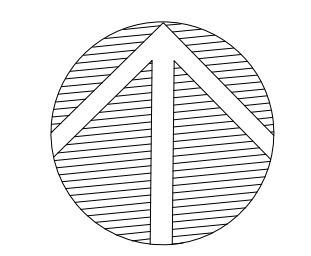

NO.	FECHA	REALIZADO	REVISADO	DESCRIPCIÓN
1				
2				
3				
4				
5				
6				
7				
8				
9				
10				

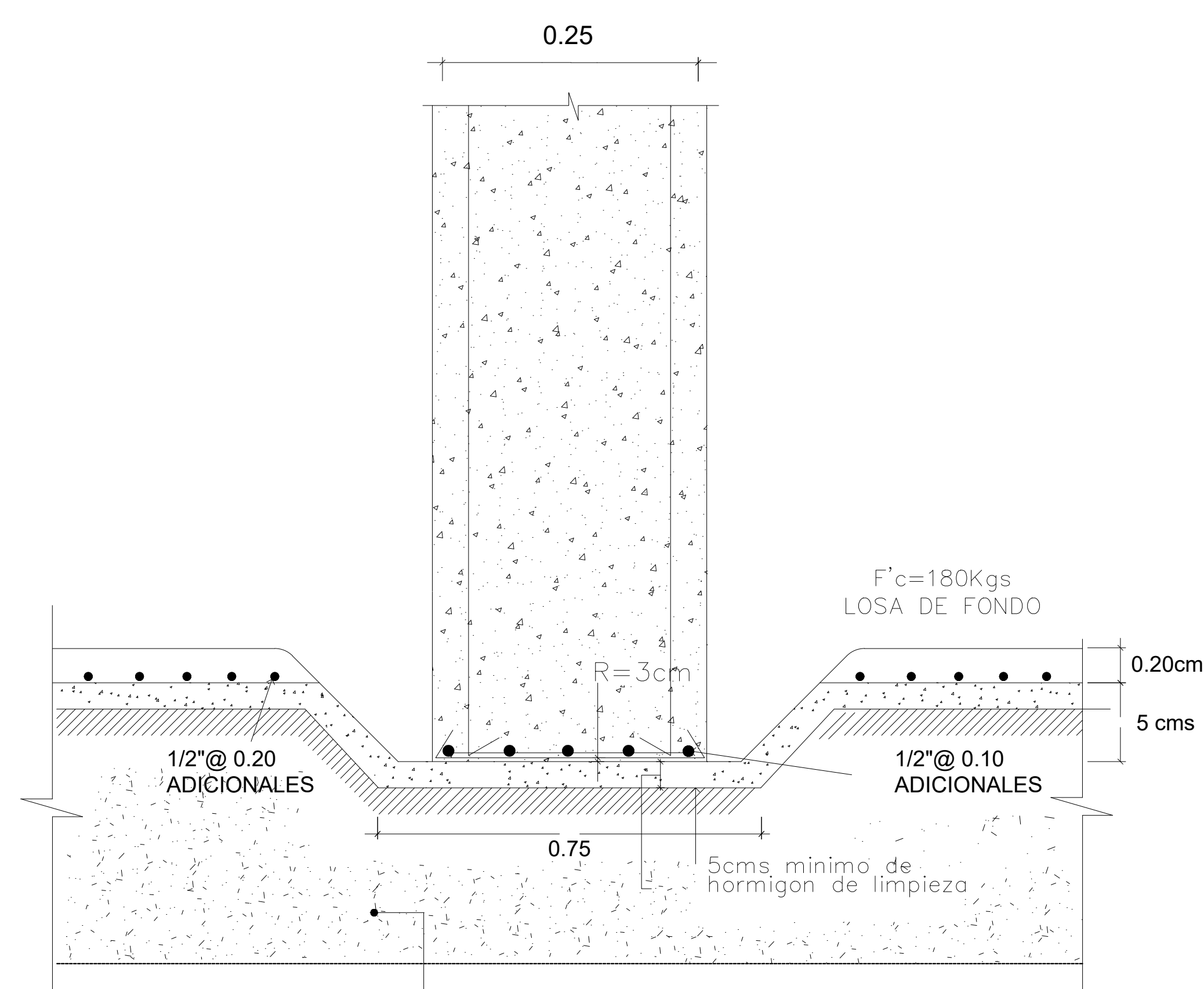

RELLENO CON MATERIAL ADECUADO Y COMPACTADO
 AL 95% DE VALOR DE SU MAXIMA DENSIDAD.

ACERO DE ZAPATA

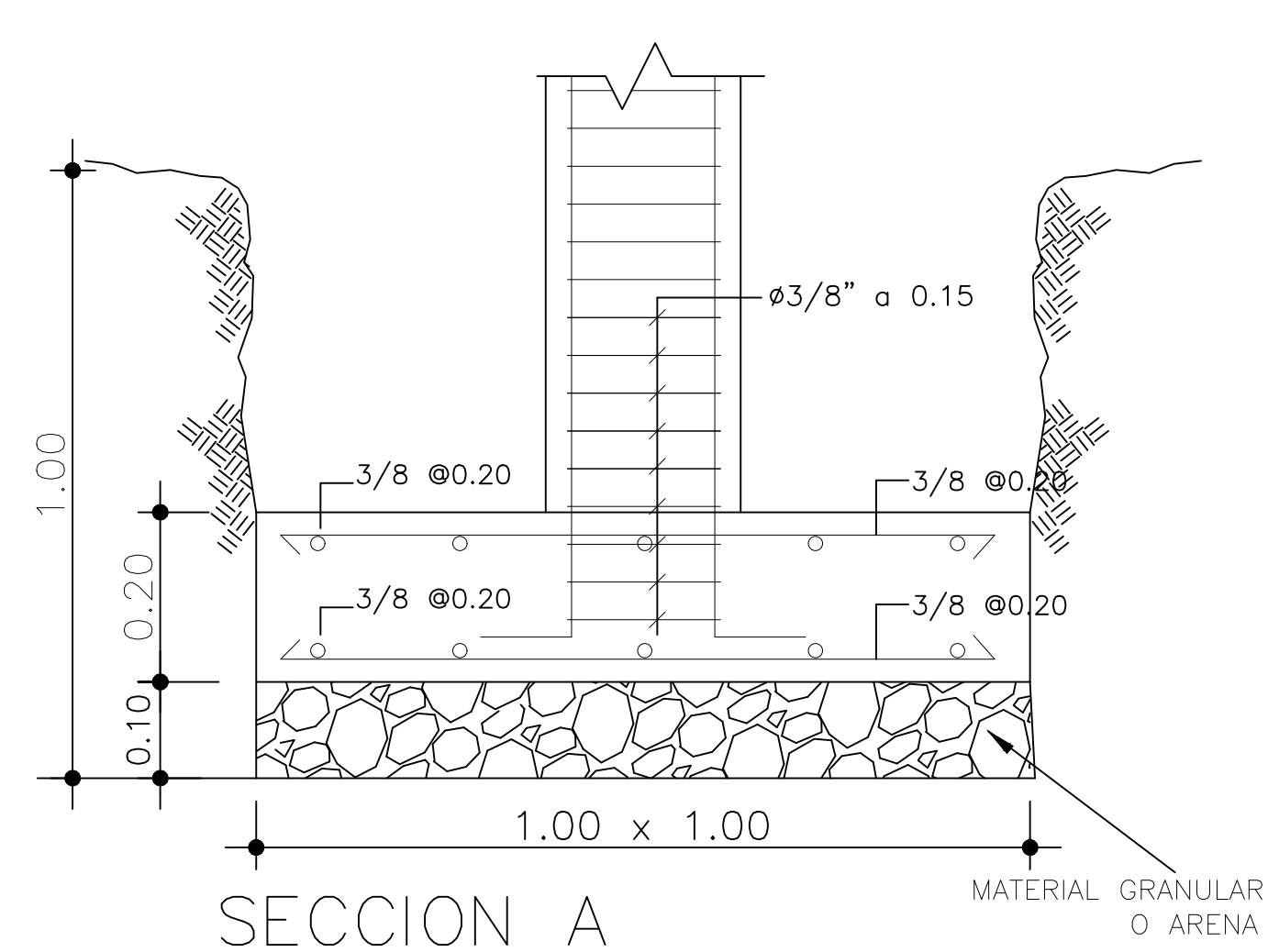

SECCION A
**Detalle Zapata de
 Columnas**

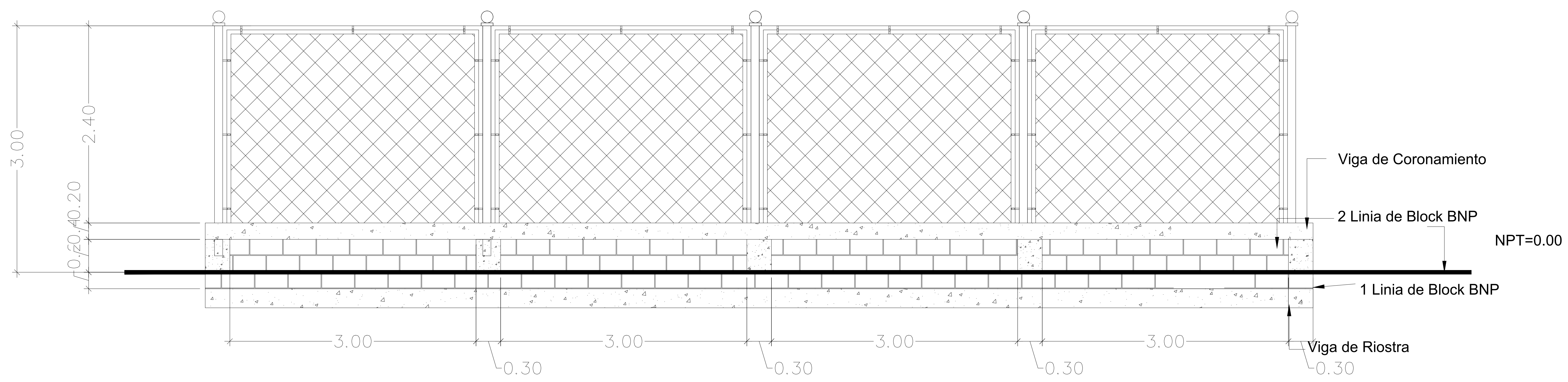
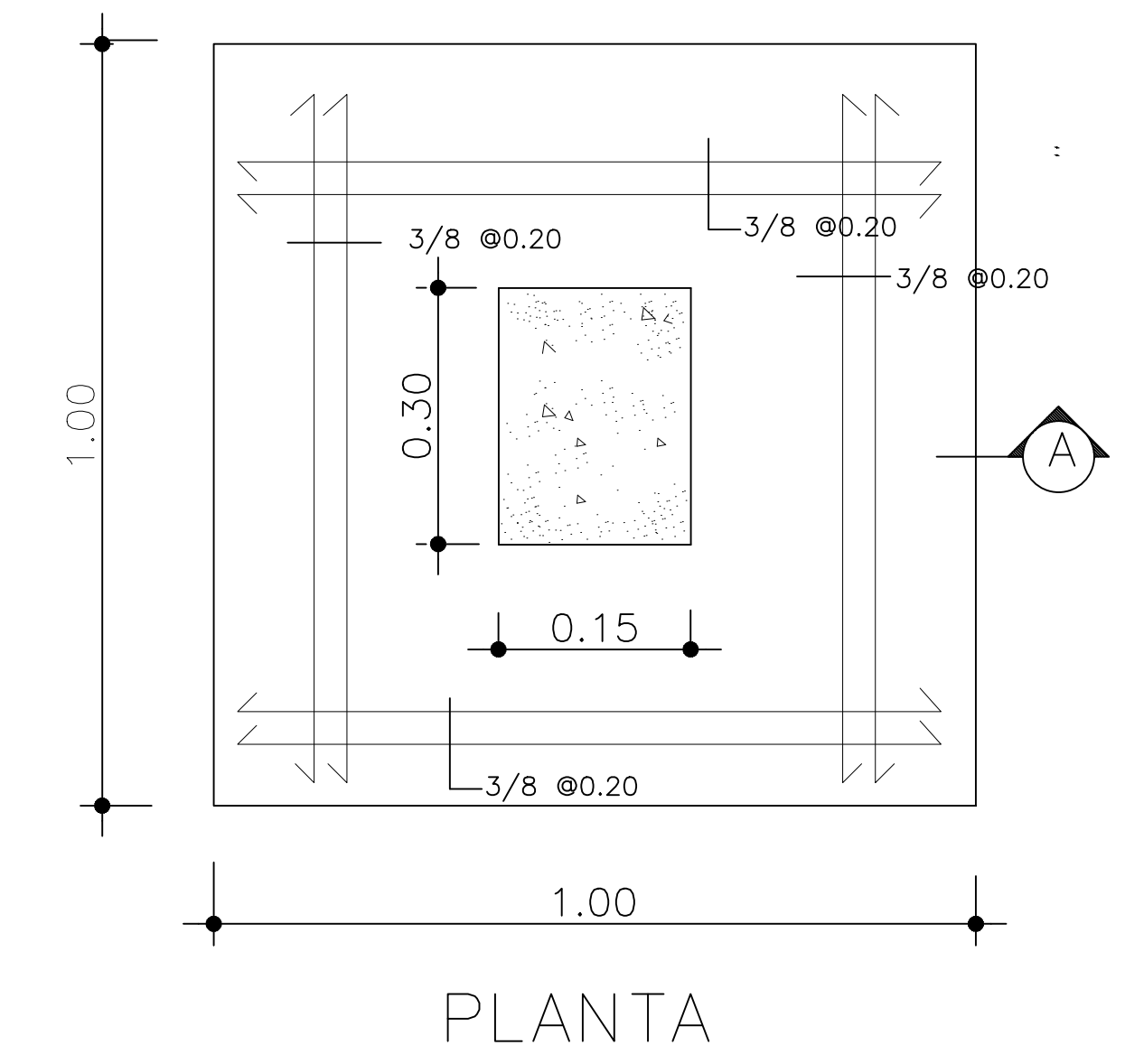

Terreno Existente

DETALLE DE VERJA PERIMETRAL



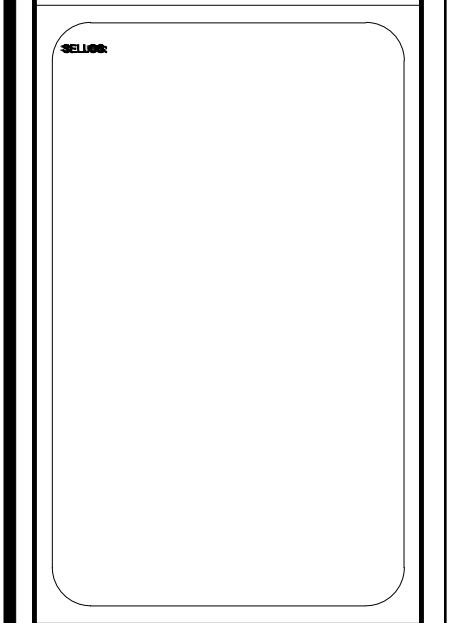
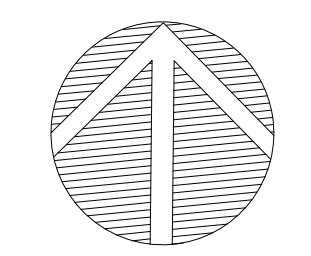

NO.	FECHA	REALIZADO	REVISADO	APROBADO
1				
2				
3				
4				
5				
6				
7				
8				
9				
10				

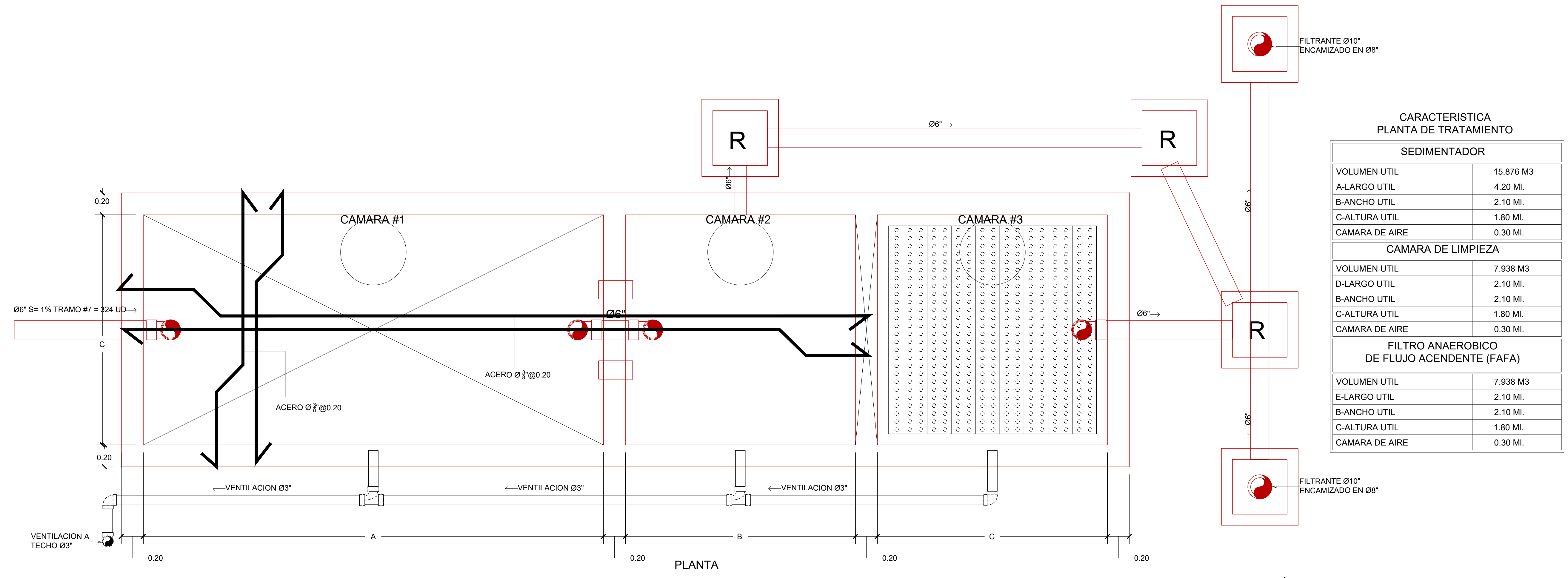

CARACTERÍSTICA PLANTA DE TRATAMIENTO

SEDIMENTADOR	
VOLUMEN UTIL	15.876 M3
A-LARGO UTIL	4.20 MI.
B-ANCHO UTIL	2.10 MI.
C-ALTURA UTIL	1.80 MI.
CAMARA DE AIRE	0.30 MI.

CAMARA DE LIMPIEZA	
VOLUMEN UTIL	7.938 M3
D-LARGO UTIL	2.10 MI.
B-ANCHO UTIL	2.10 MI.
C-ALTURA UTIL	1.80 MI.
CAMARA DE AIRE	0.30 MI.

FILTRO ANAEROBICO DE FLUJO ACENDENTE (FAFA)	
VOLUMEN UTIL	7.938 M3
E-LARGO UTIL	2.10 MI.
B-ANCHO UTIL	2.10 MI.
C-ALTURA UTIL	1.80 MI.
CAMARA DE AIRE	0.30 MI.

DT-1 PLANTA TRATAMIENTO NO ESCALA

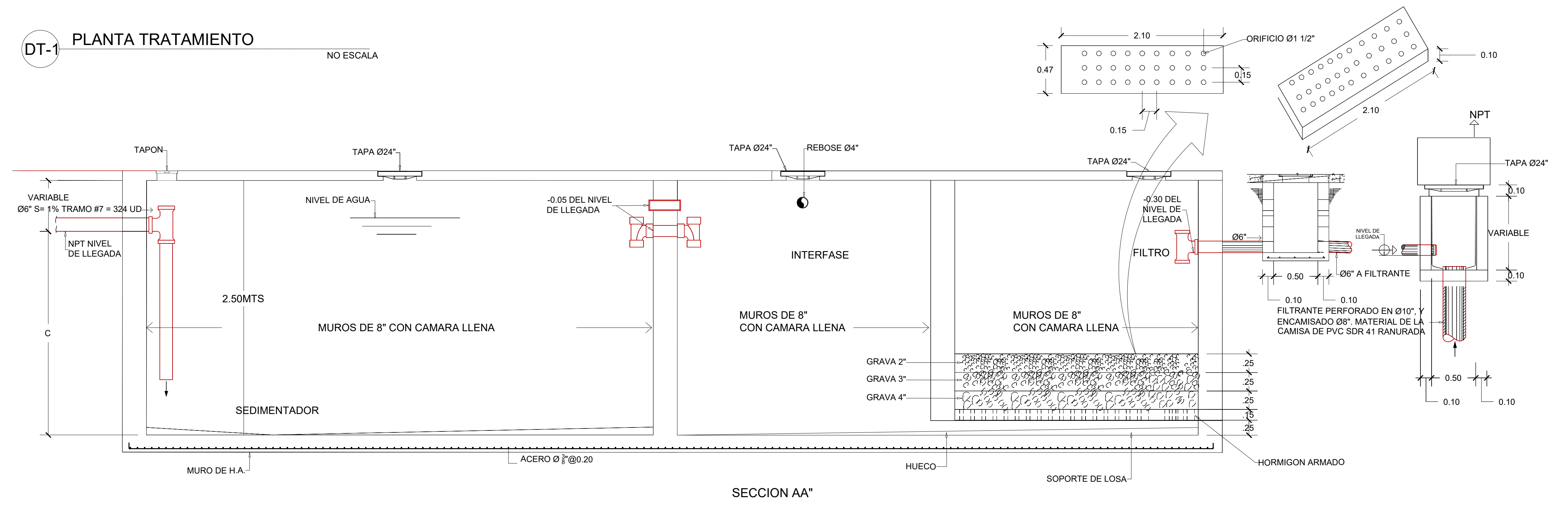

DT-1 SECCIÓN DE PLANTA TRATAMIENTO NO ESCALA

DETALLE SÉPTICO

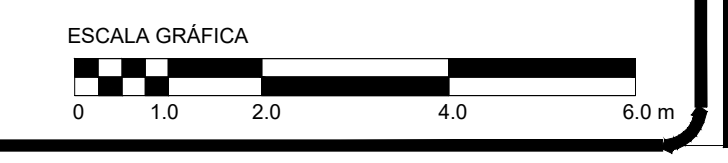

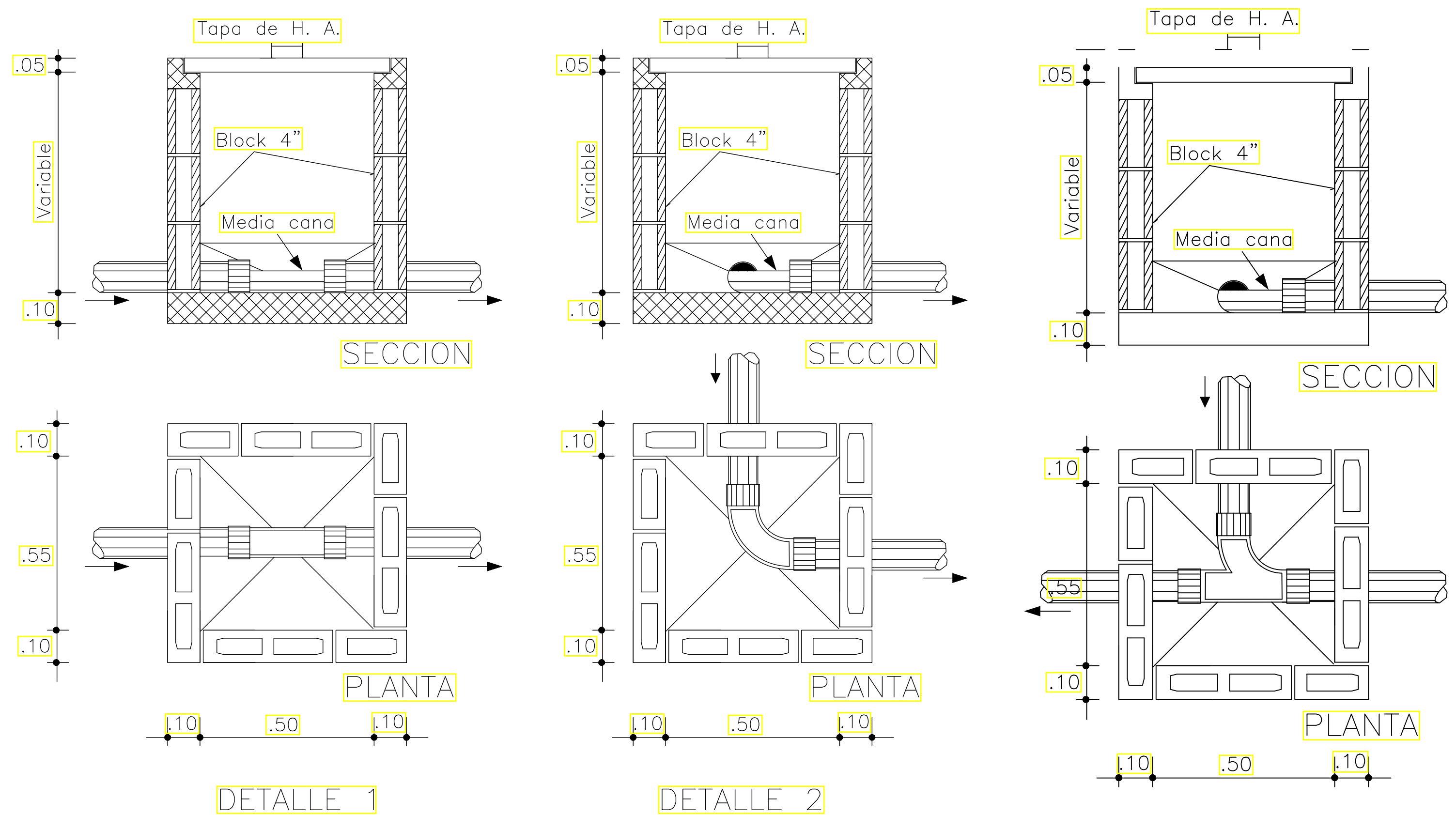

DETALLE 1
DETALLE 2
DETALLES TIPICO REGISTRO

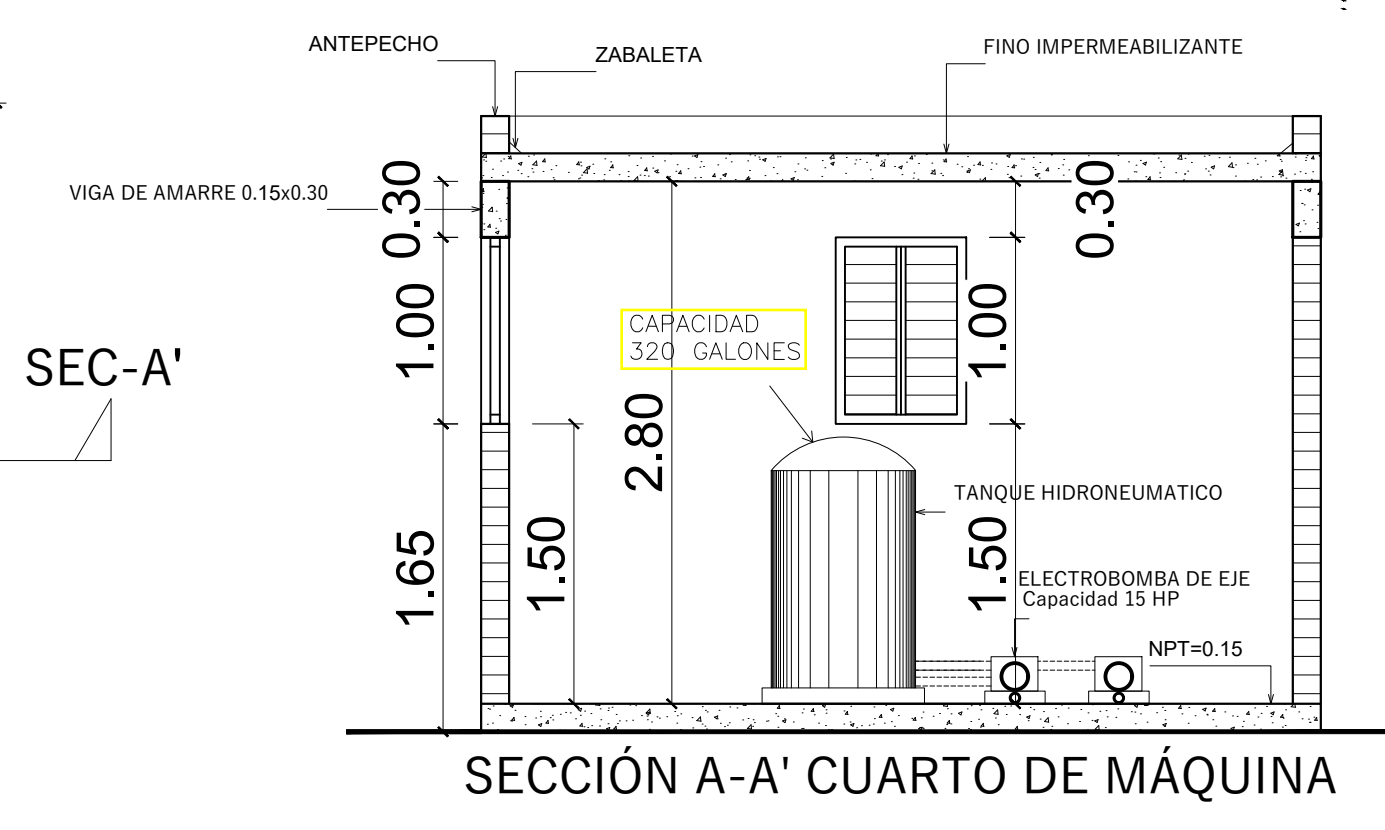
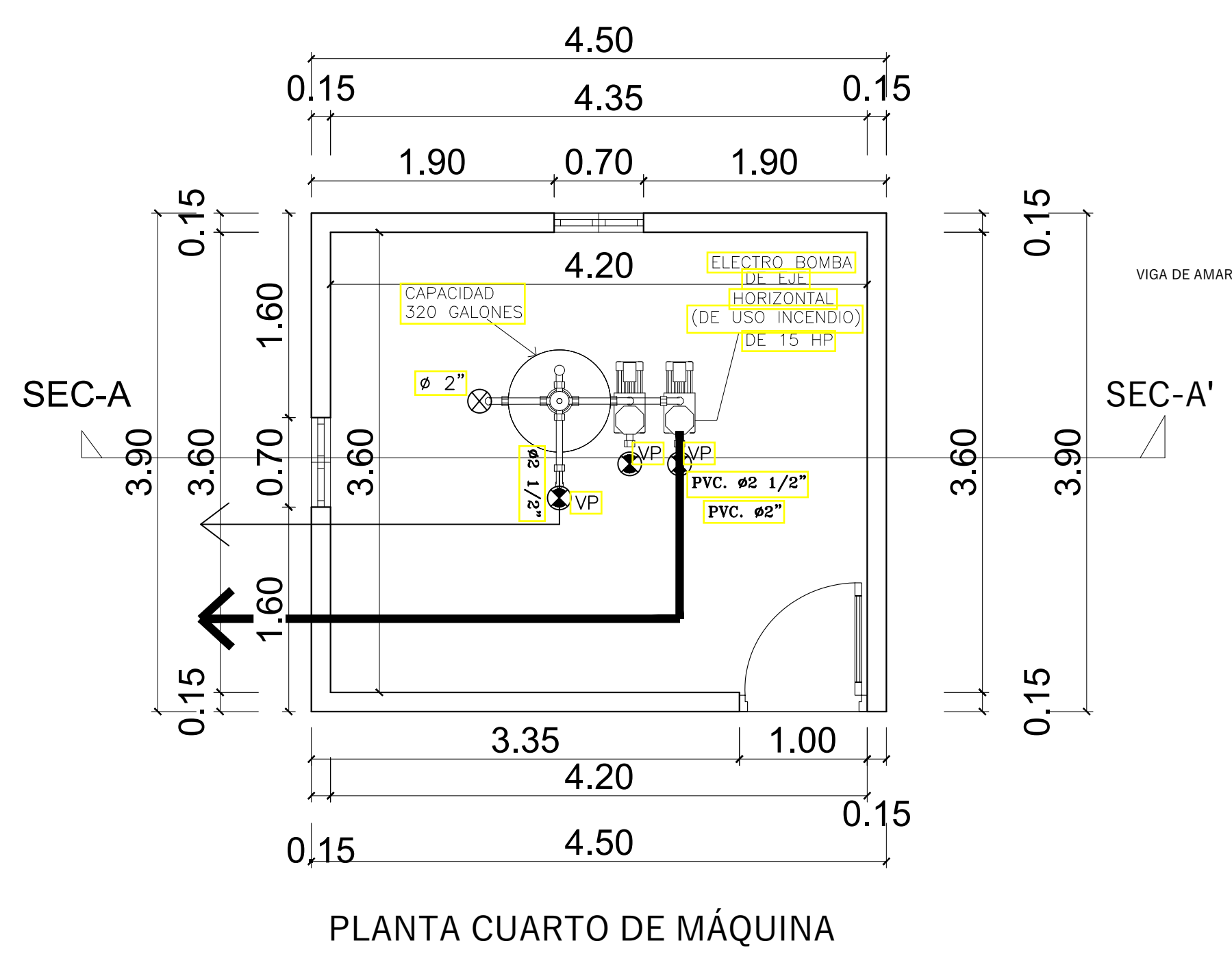

CISTERNA

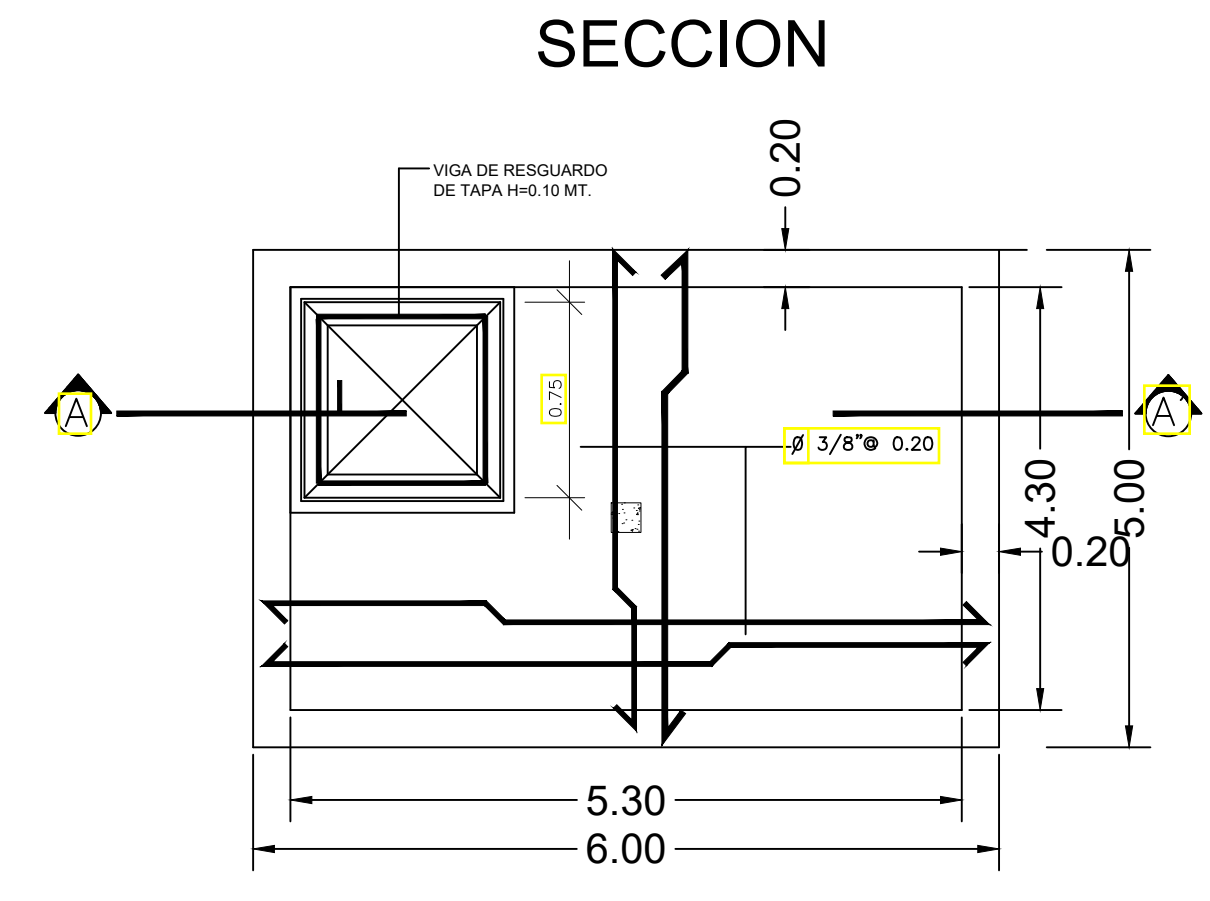
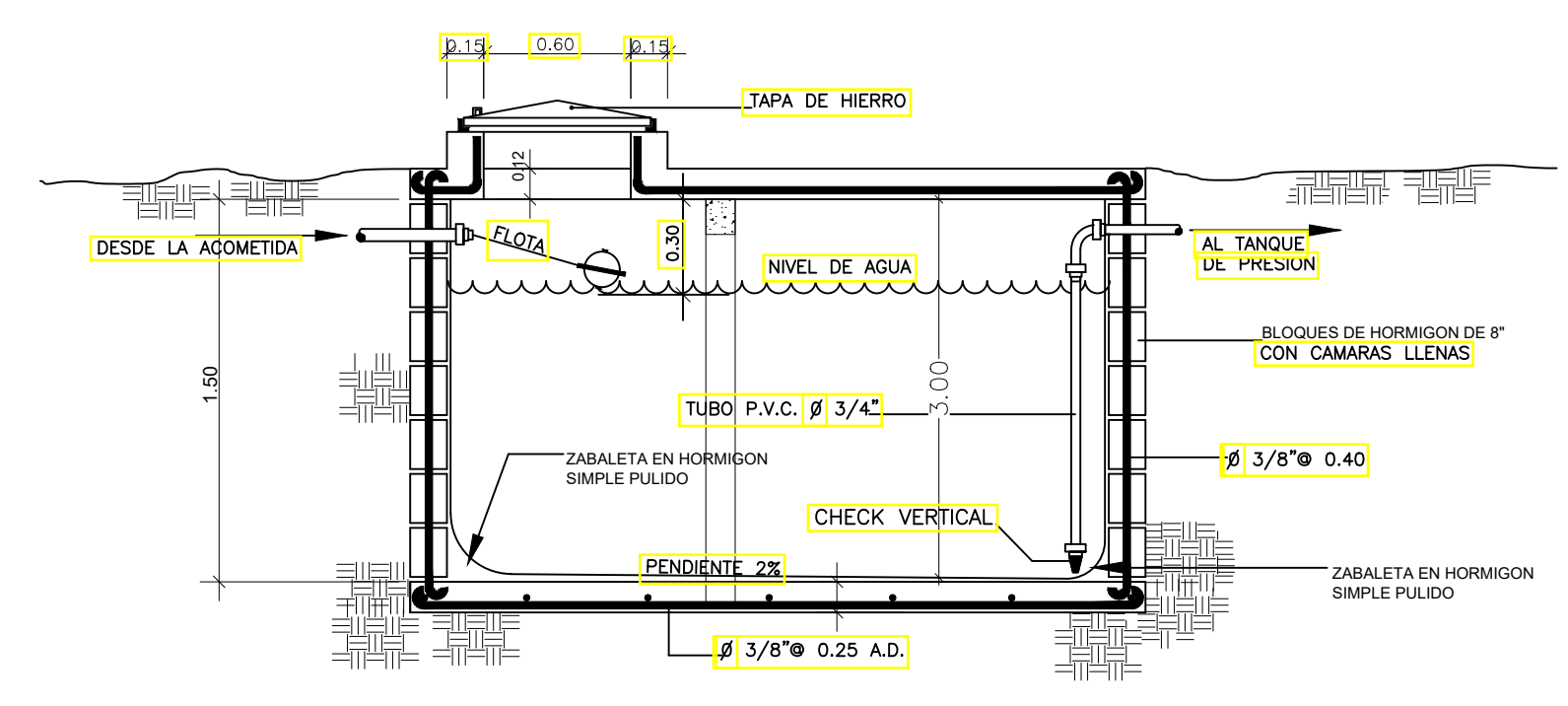

PLANTA

DETALLE SANITARIOS

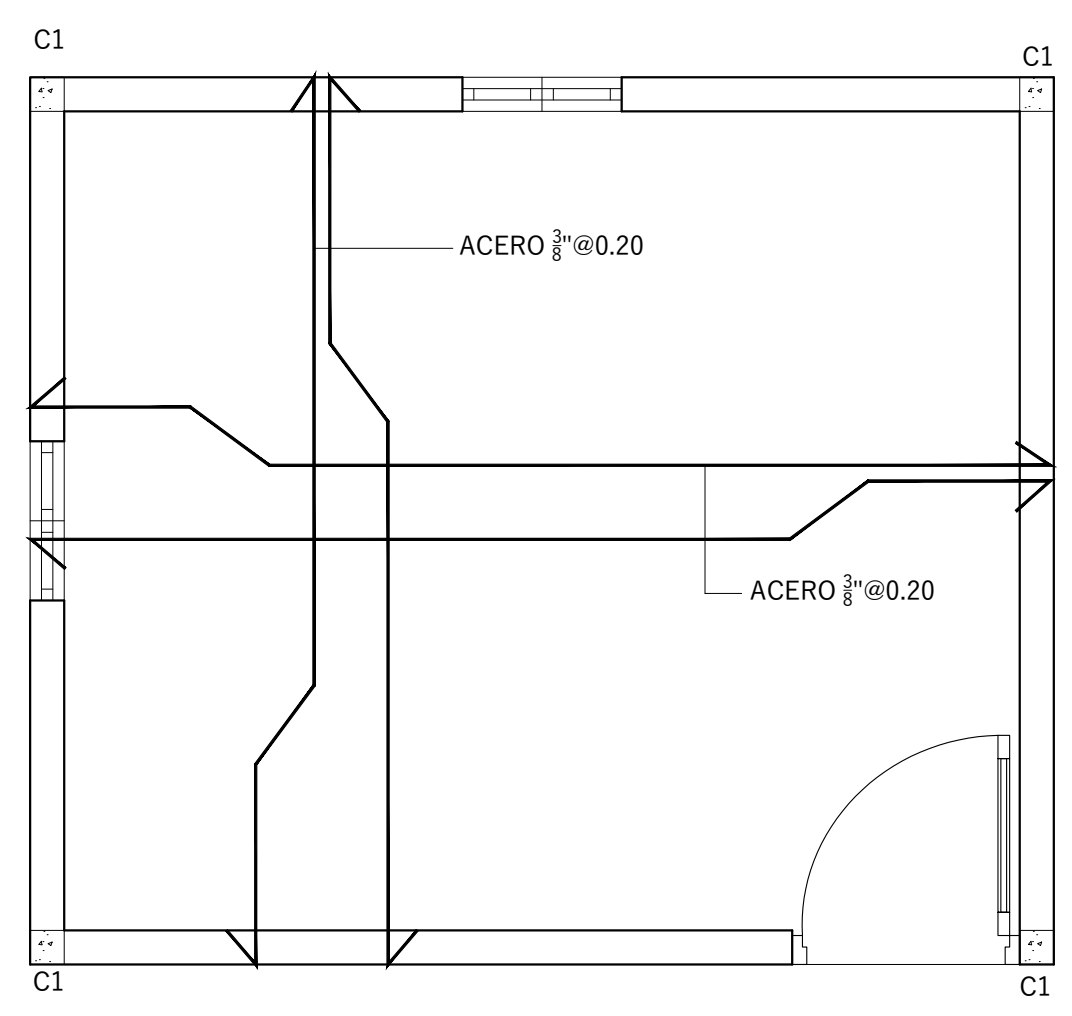

PLANTA CUARTO DE MÁQUINA

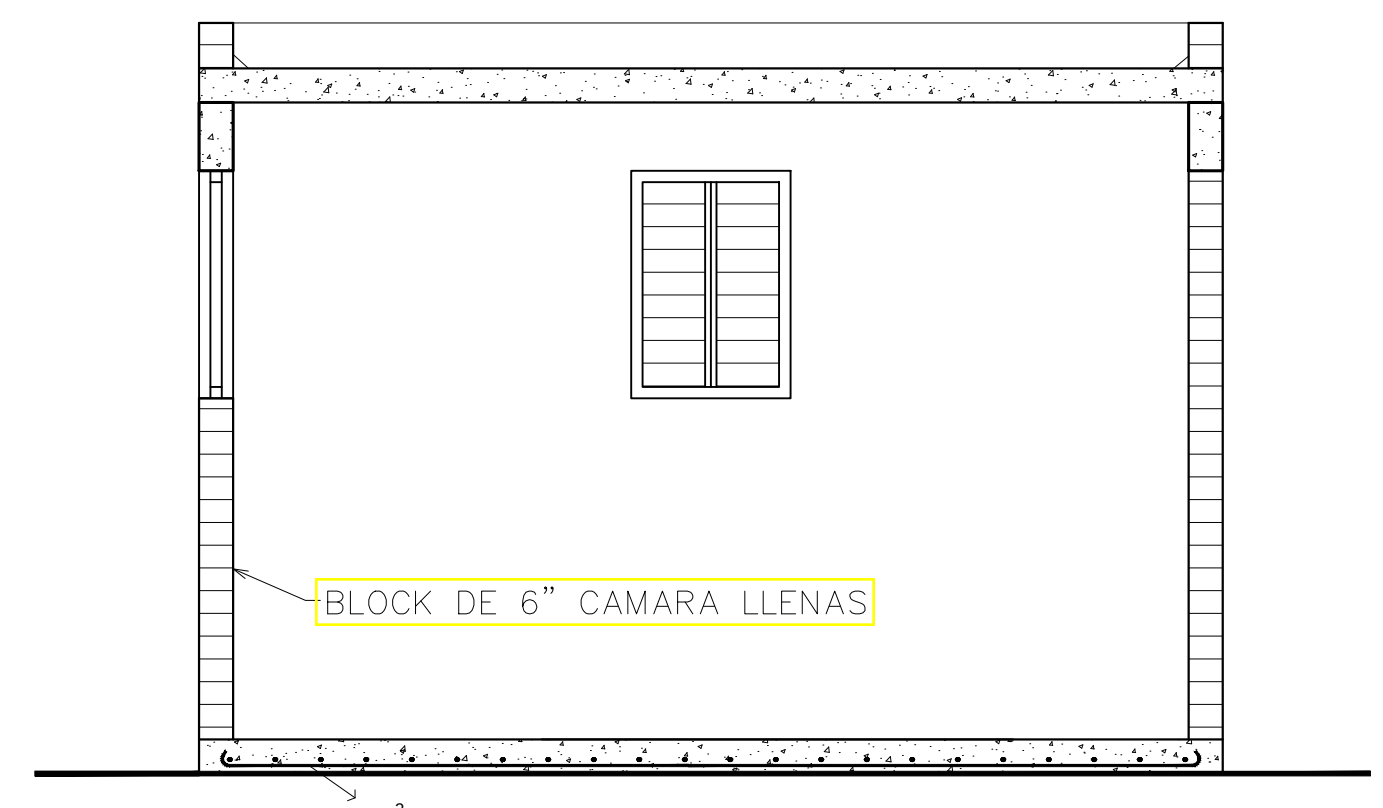

SECCIÓN A-A' CUARTO DE MÁQUINA



Logo of the **Presidencia de la República Dominicana** and **PROPEEP** (Proyectos Estratégicos y Especiales).

ING. TOMÁS MENDEZ
TOMAS.MENDEZ@PROPEEP.GOB.DO
ING. SARA DOMÍNGUEZ
SARA.DOMINGUEZ@PROPEEP.GOB.DO
ARQ. JUAN CARLOS BERRIO
JUAN.BERRIO@PROPEEP.GOB.DO

PROYECTO:
ECO-VIVIENDAS

DISEÑO ARQUITECTÓNICO
DISEÑO ESTRUCTURAL
DISEÑO ELÉCTRICO
DISEÑO SANITARIO

NO.	FECHA	REALIZADO	REVISADO	APROBADO
1				
2				
3				
4				
5				
6				
7				
8				
9				
10				

DISCIPLINA: ARQUITECTURA
PROYECTO: A-00
FECHA: JUNIO 2022
ESCALA: INDICADA

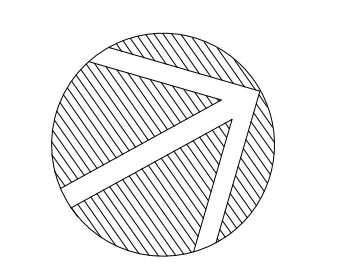

DISCIPLINA	RESPONSABLE
DISEÑO ARQUITECTÓNICO	
DISEÑO ESTRUCTURAL	
DISEÑO ELÉCTRICO	
DISEÑO SANITARIO	

DISCIPLINA	RESPONSABLE
DISEÑO ARQUITECTÓNICO	
DISEÑO ESTRUCTURAL	
DISEÑO ELÉCTRICO	
DISEÑO SANITARIO	

FECHA	MODIFICACIONES	INDICACIONES

PROYECTO:	ECO-VIVIENDAS
FECHA:	ABRIL 2022
ESCALA:	INDICADA

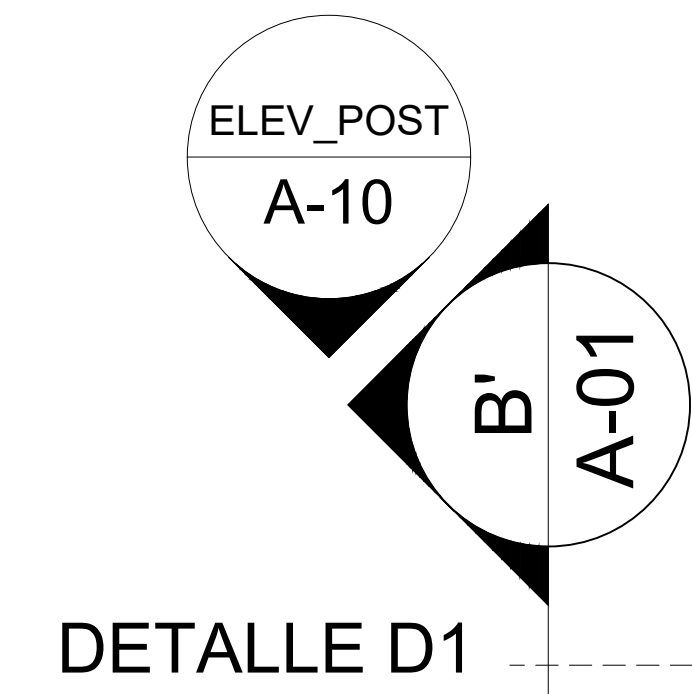
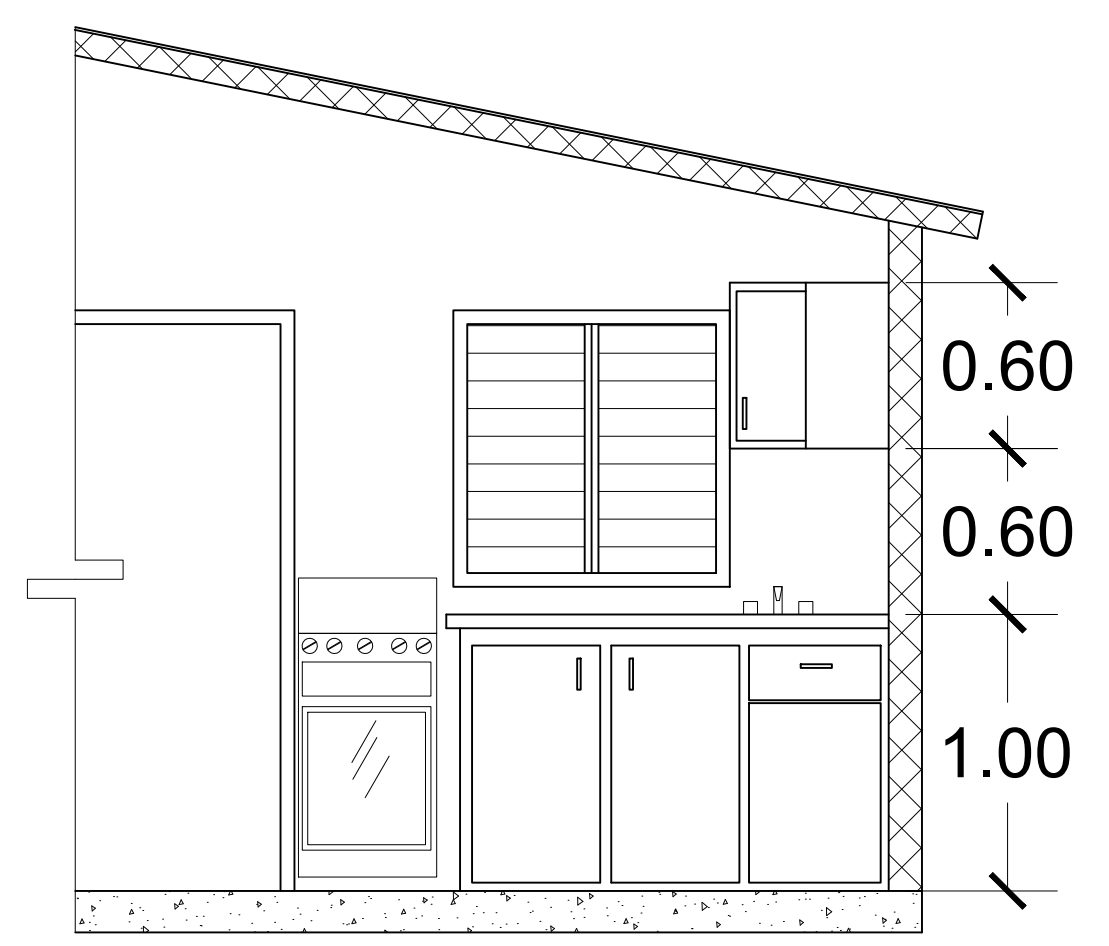

DETALLE D1

3 DETALLE D1 NO ESC:

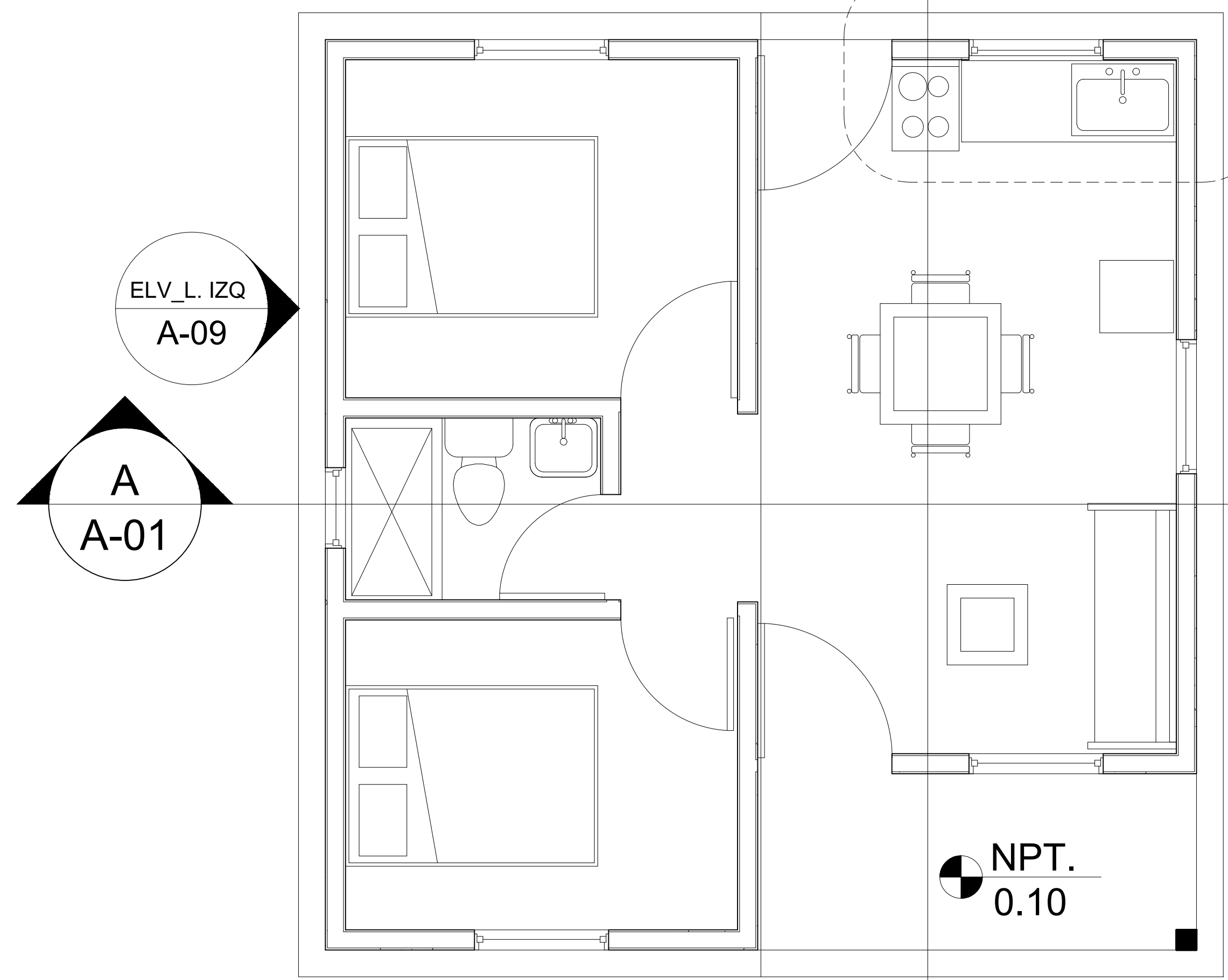

1 Planta Arquitectónica 1 : 50

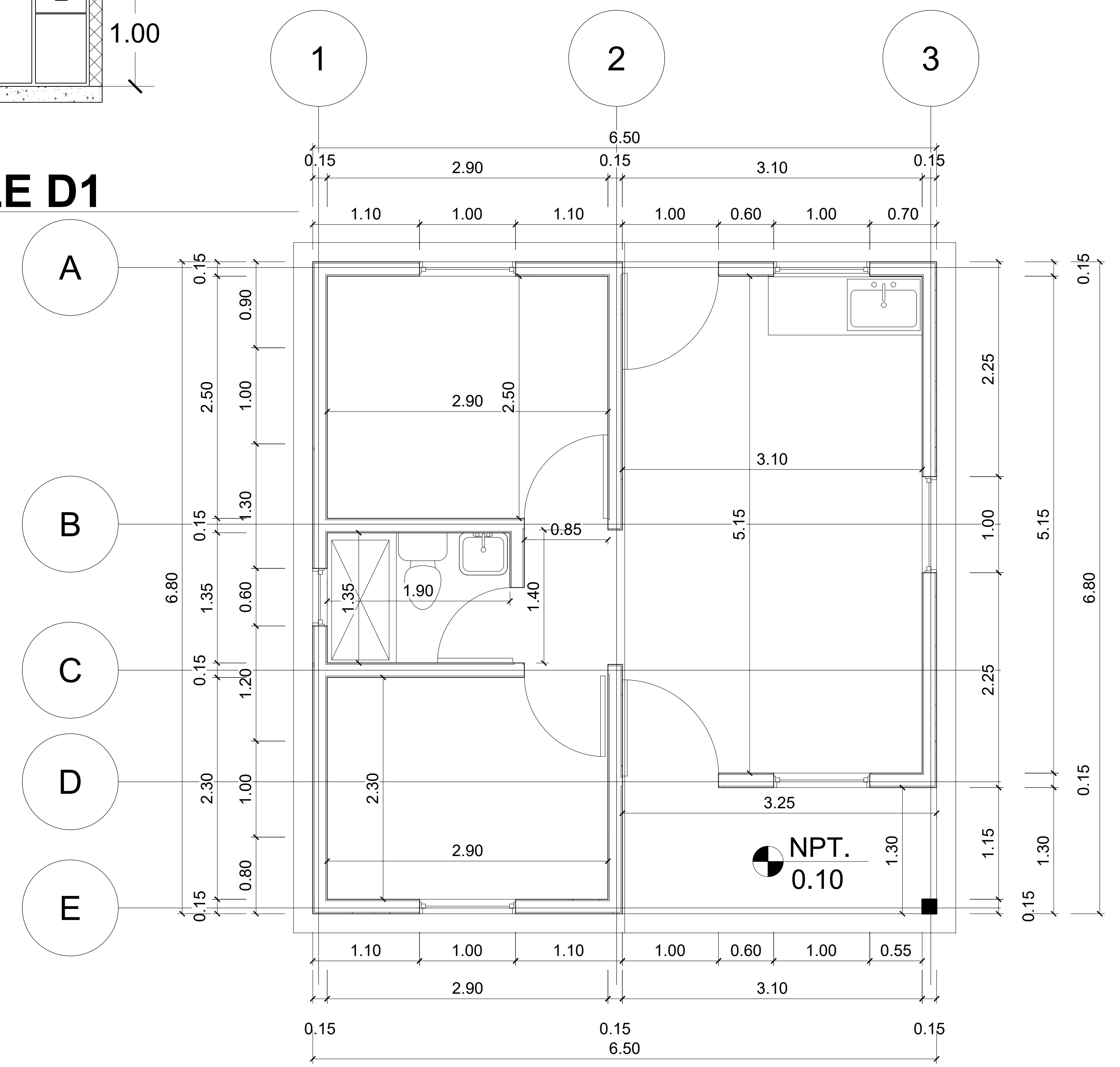

2 Planta Arq. Dimensionada 1 : 50

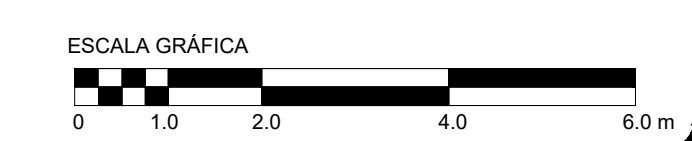

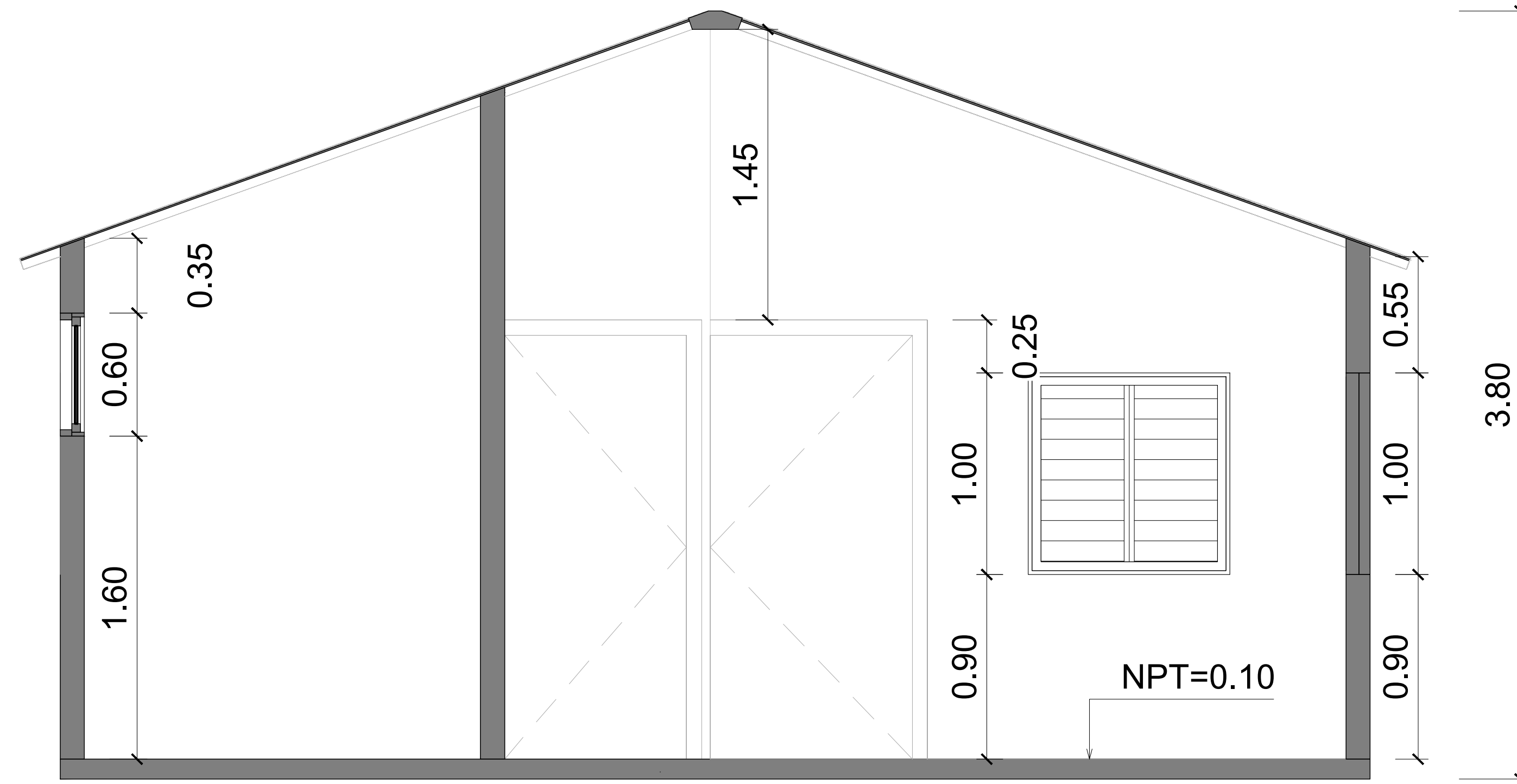

Seccion Transversal
ESC:1:20

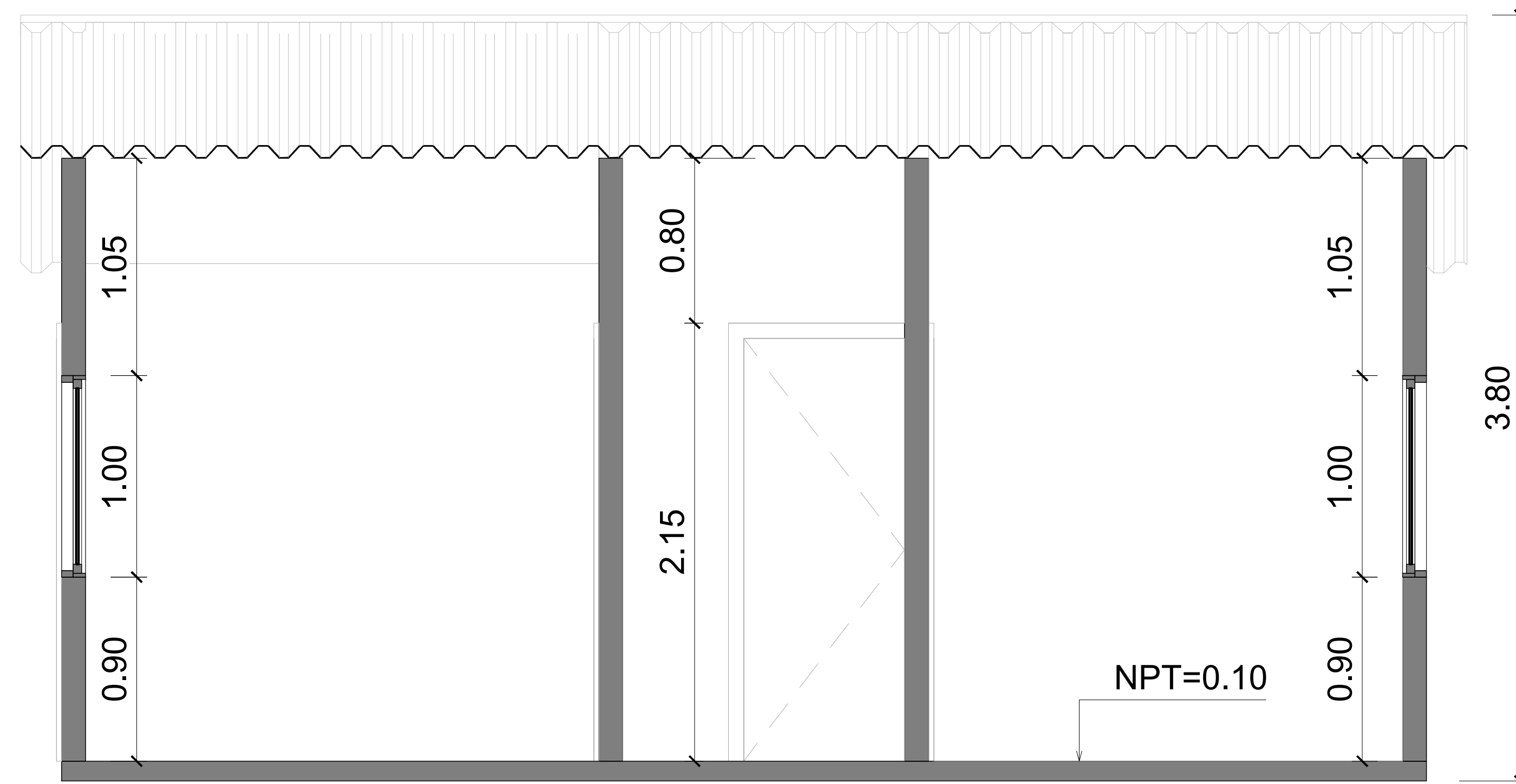

Seccion Transversal
ESC:1:20

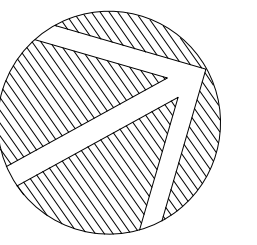
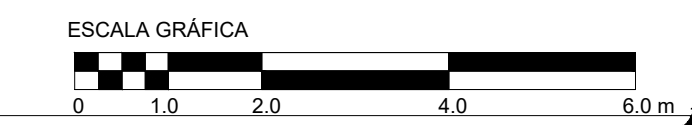

PRESENCIA DE LA
REPÚBLICA DOMINICANA
Proyectos Estratégicos y Especiales
PROPEEP

ING. TOMÁS MENÉNDEZ
TOMAS.MENENDEZ@PROPEEP.GOB.DO
ING. SARA DOMÍNGUEZ
SARA.DOMINGUEZ@PROPEEP.GOB.DO
ARG. JUAN CARLOS BERRIO CABRERA
JUAN.BERRIO@PROPEEP.GOB.DO

PROYECTO:

ECO-VIVIENDAS

ELABORADO:

REVISADO:

DISEÑO ARQUITECTÓNICO

ANÁLISIS:

DISEÑO ESTRUCTURAL

ELABORADO:

DISEÑO ELÉCTRICO

ELABORADO:

DISEÑO SANITARIO

ANÁLISIS:

REVISADO:

FECHA:

INDICADA

INDICADA

INDICADA

INDICADA

INDICADA

INDICADA

INDICADA

INDICADA

INDICADA

INDICADA

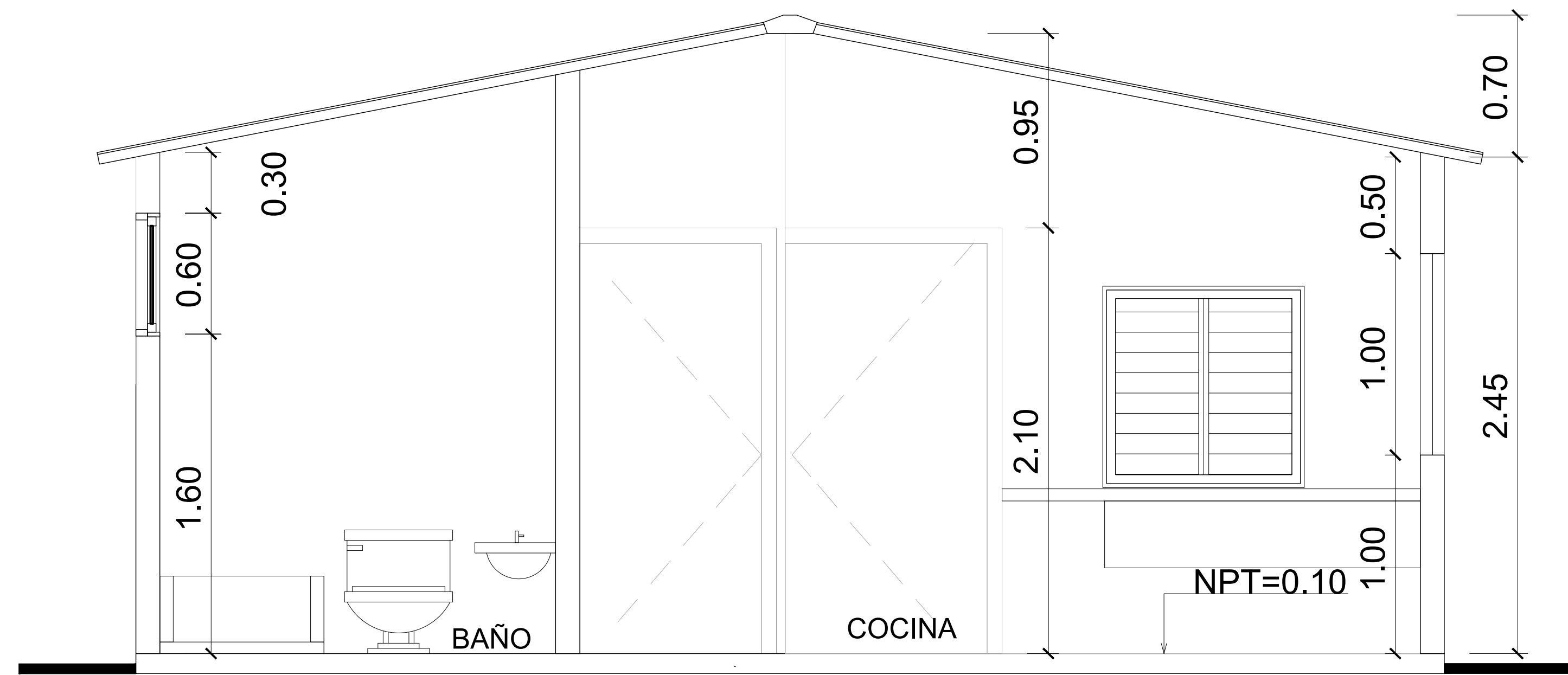

Seccion Transversal
ESC:1:20

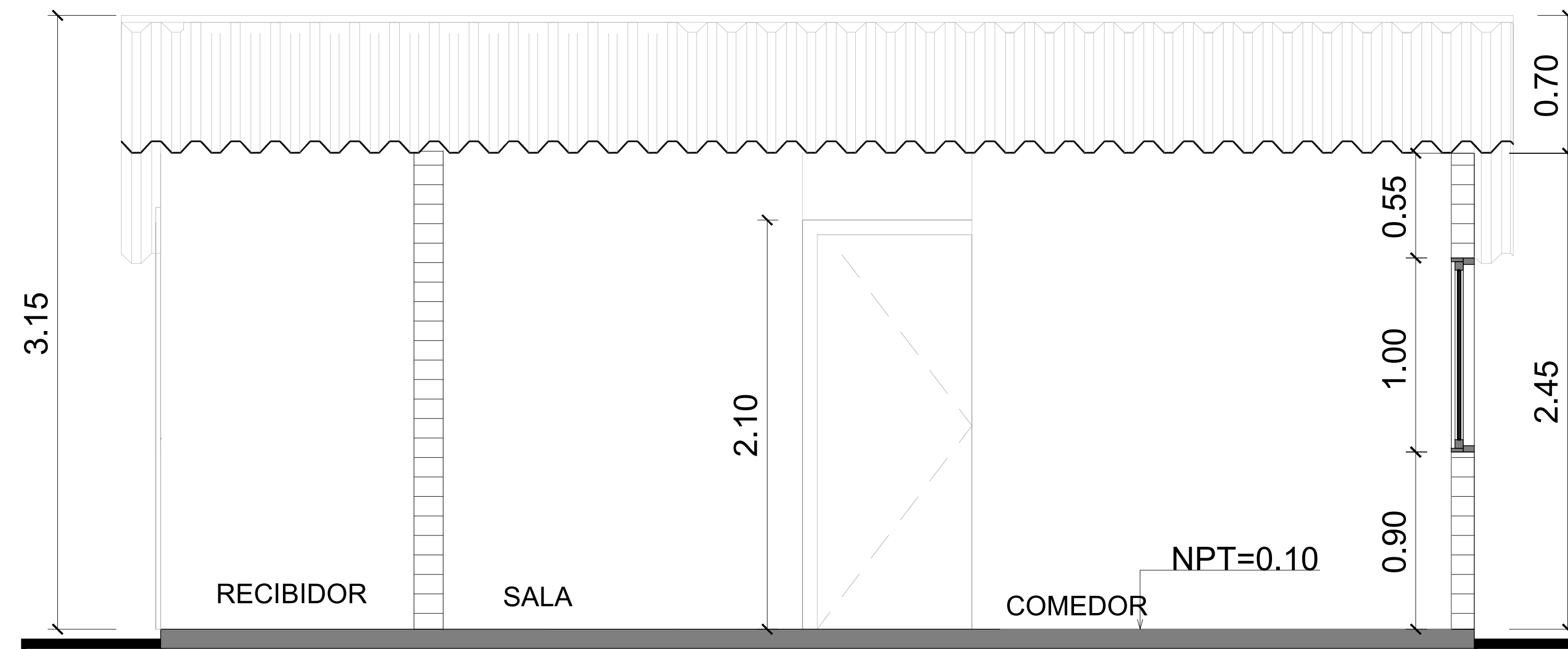

Seccion Transversal
ESC:1:20

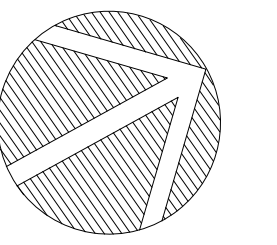
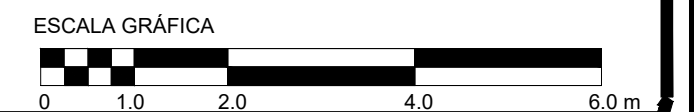

PRESENCIA DE LA
REPÚBLICA DOMINICANA
Proyectos Estratégicos y Especiales
PROPEP

ING. TOMÁS MENÉNDEZ
TOMAS.MENENDEZ@PROPEP.GOB.DO
ING. SARA DOMÍNGUEZ
SARA.DOMINGUEZ@PROPEP.GOB.DO
ARG. JUAN CARLOS BERRIO CABRERA
JUAN.BERRIO@PROPEP.GOB.DO

PROYECTO:
ECO-VIVIENDAS

ELABORADO:



REVISADO:

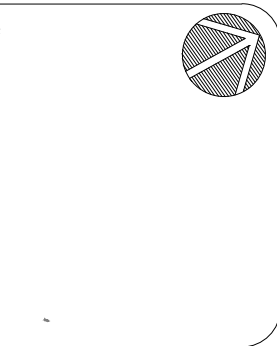

DISEÑO ARQUITECTÓNICO

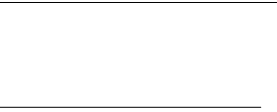

DISEÑO ESTRUCTURAL



DISEÑO ELÉCTRICO

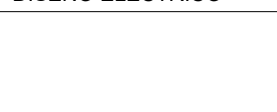

DISEÑO SANITARIO

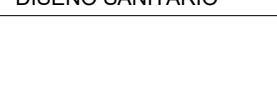

REVISADO:

NO.	FECHA	REVISADO	REVISADO	REVISADO
1				
2				
3				
4				
5				
6				
7				
8				
9				
10				

REVISADO:



DISCIPLINA:

CONVENCIONES:
A-01

FECHA:
ABRIL 2022

INDICADA

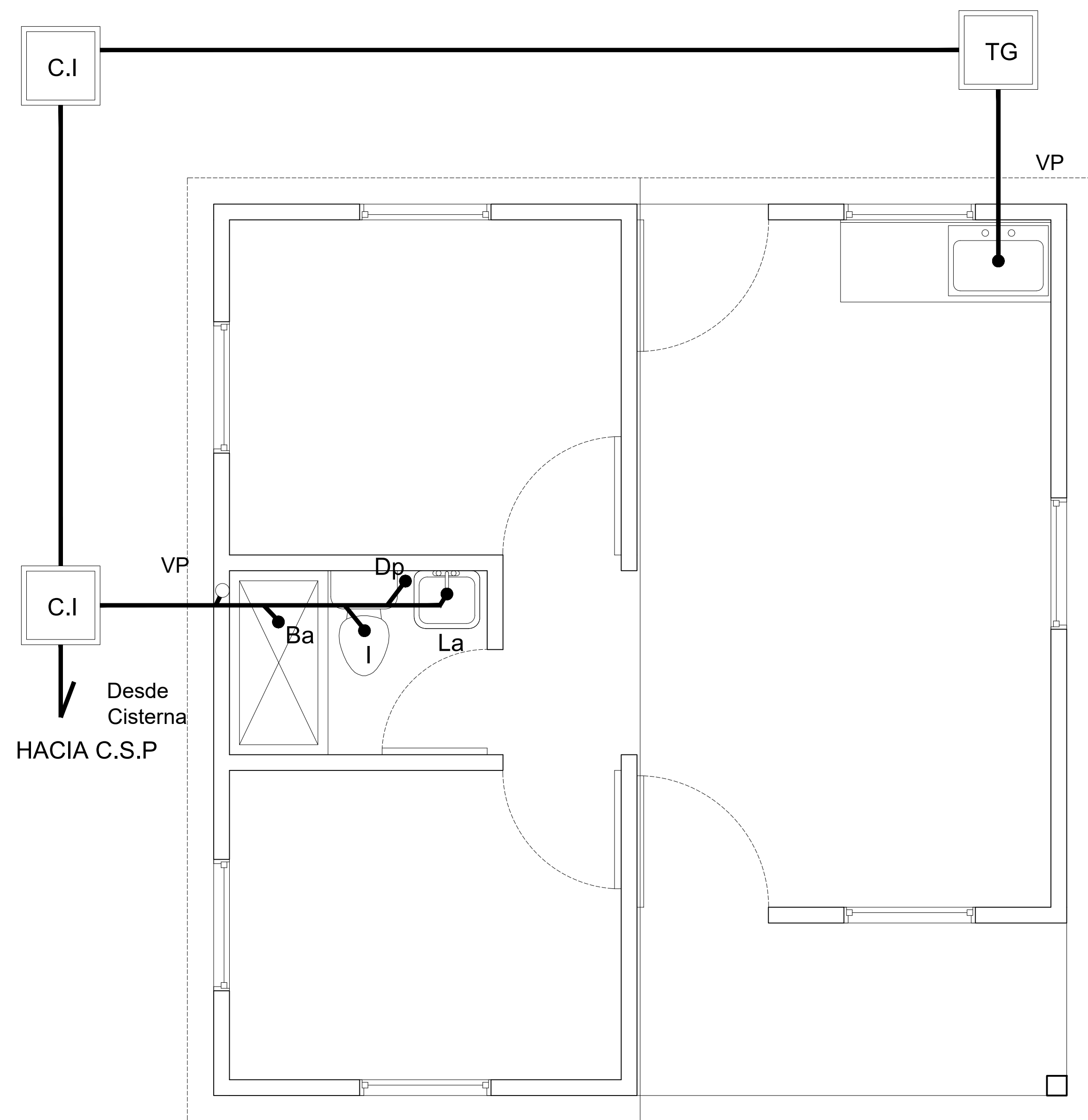

1 **Planta Hidrosanitaria Agua Residual**
1 : 50

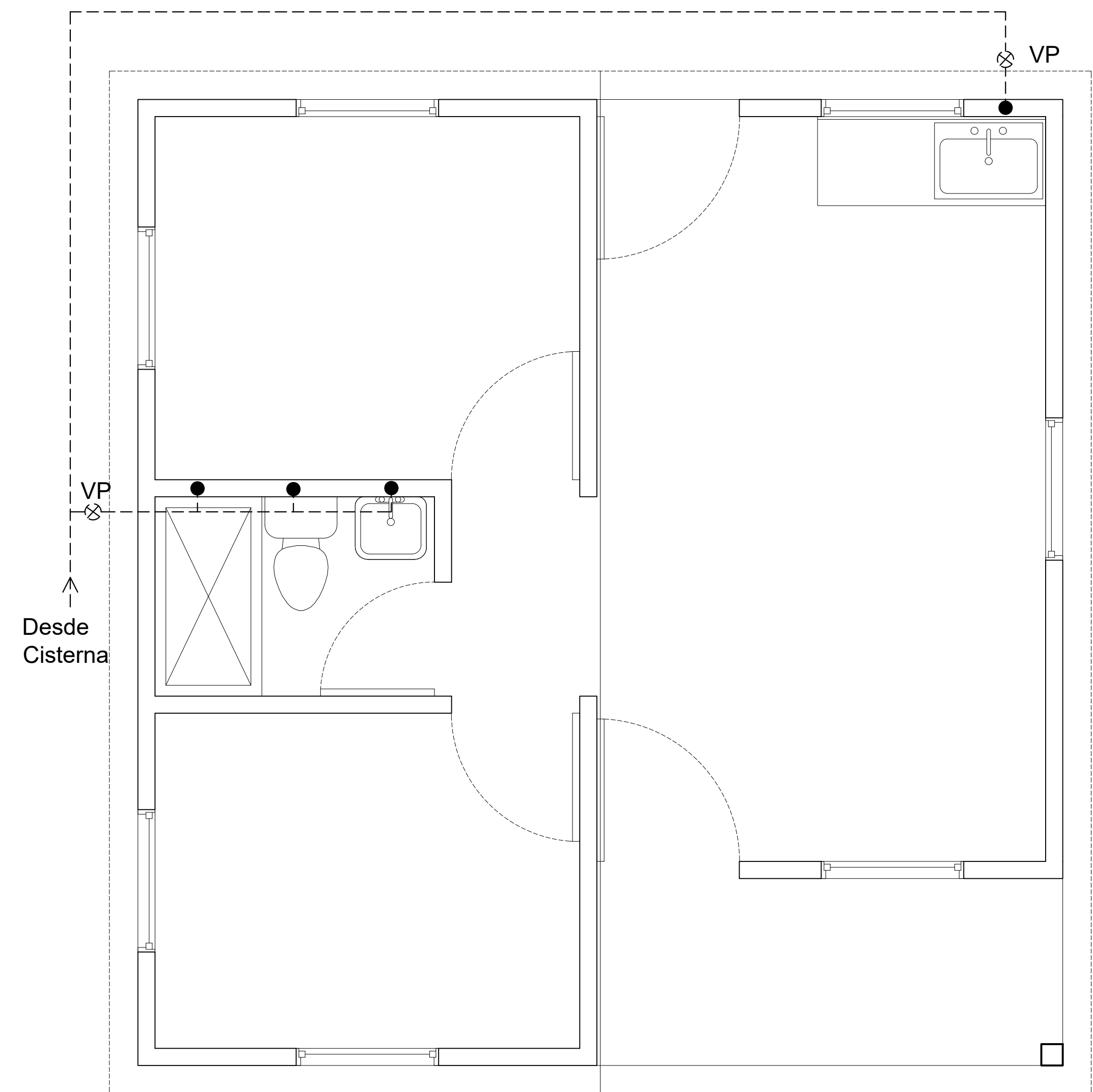

2 **Planta Hidrosanitaria Agua Potable**
1 : 50

DISEÑO ARQUITECTÓNICO

Departamento de Ingeniería e infraestructura.

NOMBRE DEL PROYECTO

VIVIENDA PROPEEP 44mt2

DIRECCION

NOMBRE DE LA HOJA

PLANOS ARQUITECTÓNICOS

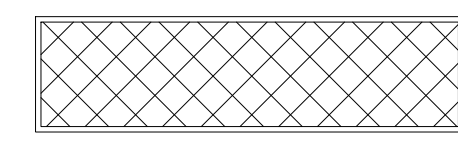
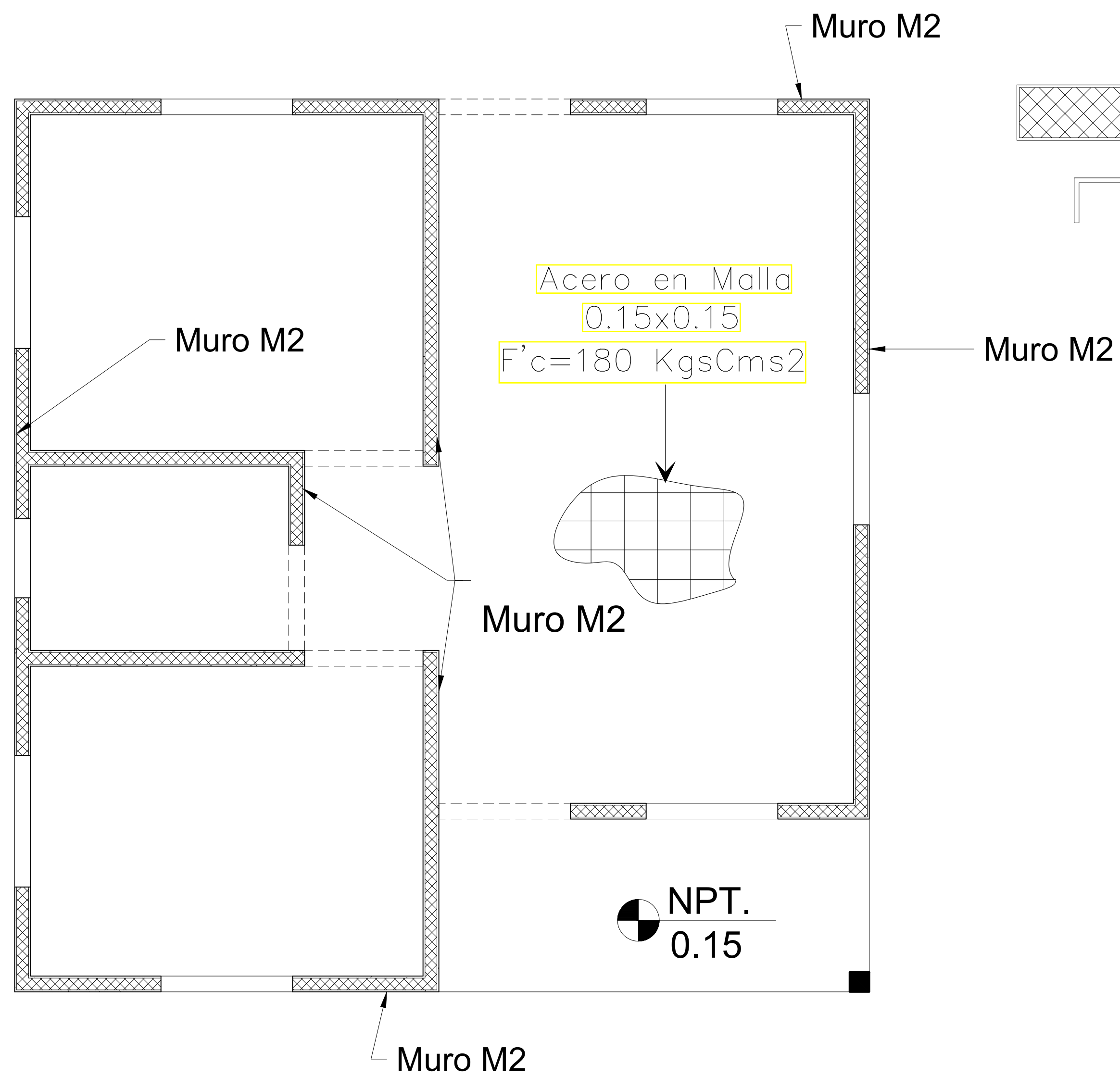

Muro de Poliestireno Expandido. con Malla Electrosoldada.

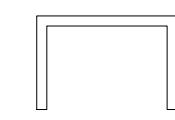

Malla de Conexiones Tipo U en Ventanas y Puertas.

1 **Planta Estructural Sistema M2**
1 : 50

2 **Detalles Constructivos (Ver PDF) Adjunto**
1 : 50

DISEÑO ARQUITECTONICO

Departamento de Ingenieria e infraestructura.

NOMBRE DEL PROYECTO

VIVIENDA PROPEEP 44mt2

DIRECCION

NOMBRE DE LA HOJA

PLANOS ARQUITECTÓNICOS